

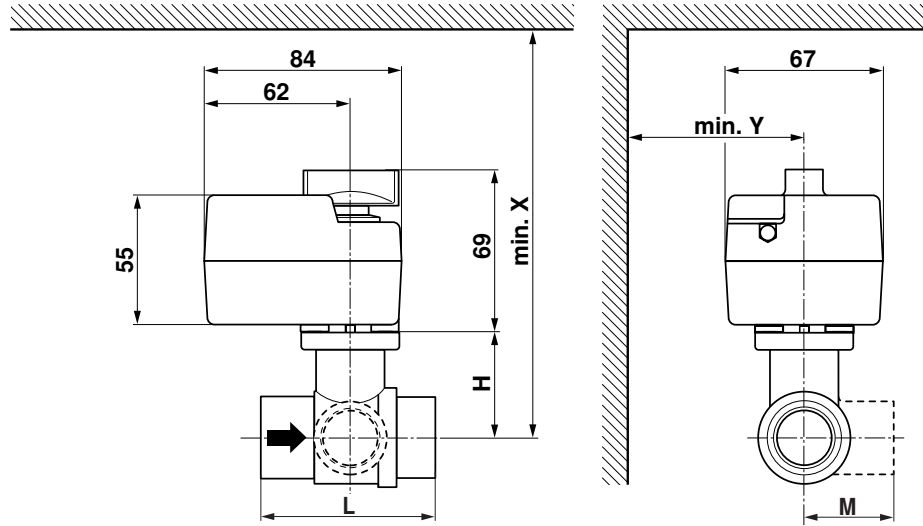

TRD24-SR (-T)  
TR24-SR (-T)  
TRY24-SR

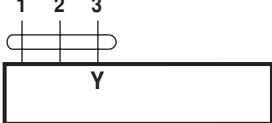

70632-00001.C

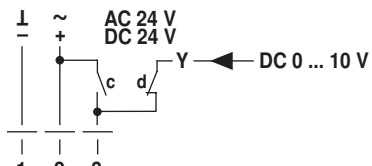
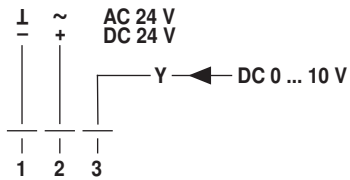

c	d		
			A - AB = 100%
			A - AB = 0%

		°C	DN		Rp	G	PN	mm								
			max.	mm				"	"	"		L	H	M	TRD24-SR(-T)	
													X	Y	X	Y
R2..K	R3..K	100	10	3/8	3/8			52	35	28	174	75				
R4..K	R5..K	100	10	3/8		3/4		69	31.5	34	171	75				
R2..	R3..	100	15	1/2	1/2			67	45	39					184	75
R4..	R5..	100	15	1/2		1		74	44	38					183	75
R6..R	R7..R	100	15	1/2			6	101.5	45	73					184	80
R4..DK		130	10	3/8		3/4		65	38	13					177	75

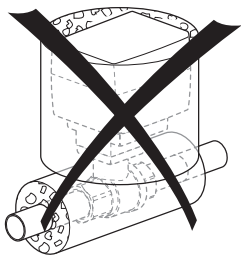
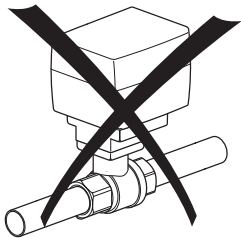
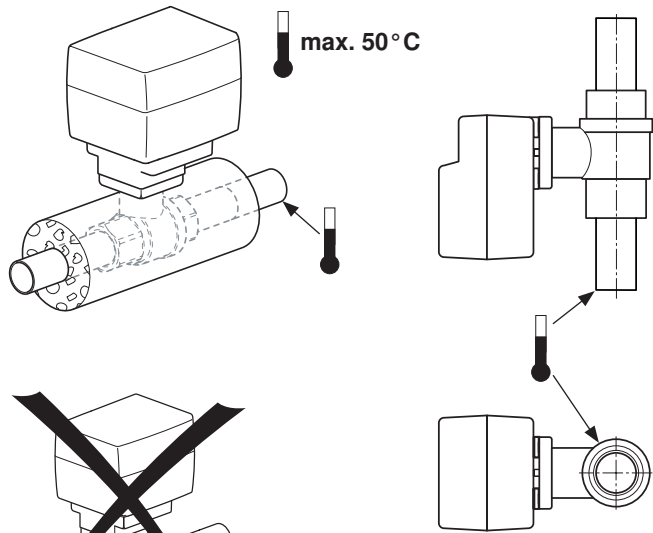
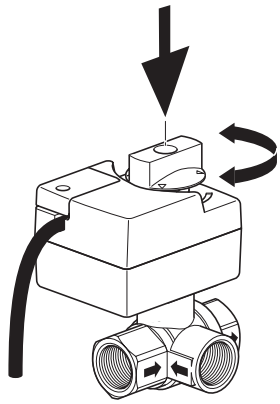

	R2..K	R3..K	max. 100 °C
	R4..K	R5..K	max. 100 °C
	R2..	R3..	max. 100 °C
	R4..	R5..	max. 100 °C
	R6..R	R7..R	max. 100 °C
	R4..DK		max. 130 °C

