

Belimo – Applications

Room and zone control

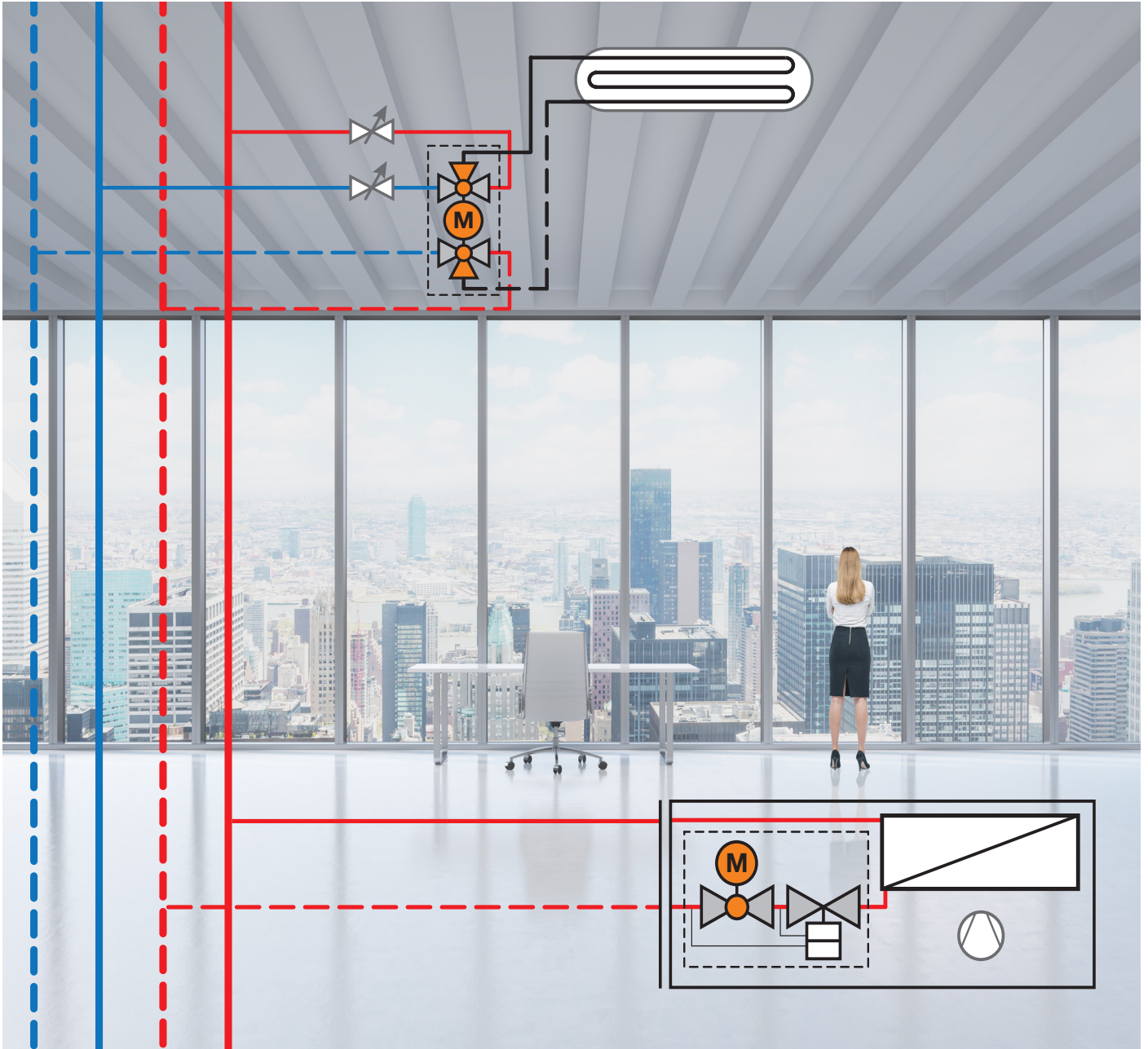

International 2016

Definition and Positioning of Belimo ZoneTight™

BELIMO
ZoneTight™

Belimo ZoneTight™ designates Belimo regulating devices that are used for room and zone applications in air-conditioning technology with tight spaces.

ZoneTight consists of two names:

- Zone** stands for room and zone applications
- Tight** stands for a tight closing valve

Energy efficient

- Zero-leaking products guarantee no loss of energy due to leakage
- Used technology stands out due to its high levels of efficiency and low power consumption

Reliable

- Belimo ball valve technology is resistant to poor water quality
- Technology used is reliable and allows low operating costs
- 5 years guarantee of Belimo products

Compact

- Exceptionally compact construction with a minimal amount of height and width space required allows space-saving solutions since these products have been developed for use in zones/rooms

Products and Applications

	Fan Coil 	Fan Coil (heating and cooling) 	Cooling ceiling 	Heating and cooling ceiling 	Floor heating 	Radiator 
QCV 	Established usage	Possible usage	Established usage	Possible usage	Established usage	Established usage
PIQCV 	Established usage	Possible usage	Established usage	Possible usage	Established usage	Established usage
6-way 		Established usage		Established usage		
6-way EPIV 		Established usage		Established usage		

established usage
 also recommended usage
 possible usage

Compact zone valve QCV. Robust, flexible, tight-sealing.

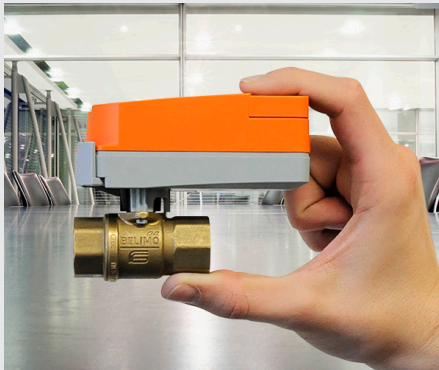

The space-saving QCV (Quick Compact Valve) is available as a 2-way characterised control valve with nominal diameters of DN 15 and DN 20 and also as a 3-way change-over ball valve with the same nominal diameters.

- Tight-sealing characterised control valve prevents circulation losses
- Manually adjustable k_v values with the 2-way characterised control valves
- Automatic adaptation to set k_v value
- Minimum power consumption in operating and standby modes
- Compatible with 24 V, 230 V, open-close/3-point, modulating control and MP-Bus®

Pressure-independent zone valve PIQCV. Compact, flexible and efficient.

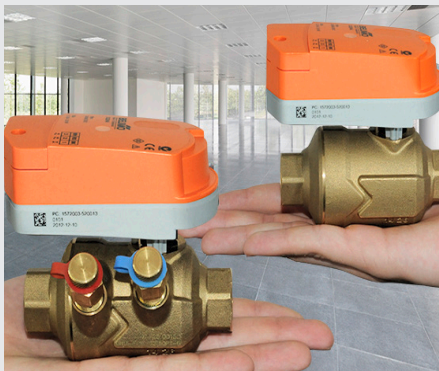

The PIQCV (Pressure Independent Quick Compact Valve) is a pressure-independent characterised control valve which permanently supplies all heating and cooling elements with precisely the amount of water needed.

- Ideal room comfort is achieved as the optimum amount of water is supplied to the end devices
- High energy efficiency thanks to the low differential pressure required
- Little planning work thanks to fast and reliable valve selection
- Time saving by the automatic and permanent hydraulic balancing
- Flexible, diverse installation options thanks to compact design

Precise 6-way zone valve. Compact, safe, economical.

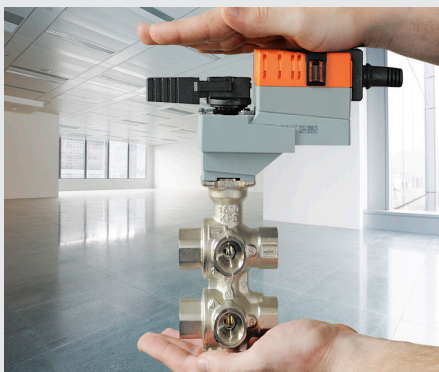

The 6-way zone valve is used for the control of one terminal unit in 4-pipe operation, usually a cooling or heating ceiling or an air-conditioning beam. As a result of its unique technology – just one valve, one actuator and one control sequence – it revolutionises the structure of these systems and replaces conventional solutions (four 2-way valves, four actuators and two control sequences).

- Versatile k_{vs} combinations enable precise and effective control
- Compact and trouble free installation in suspended ceilings
- No assembly error as it is impossible to mix up the valves
- Operating safety through reliable decoupling of cooling and heating circuit
- Maximum plant safety through integrated pressure relief function (patent pending)

Pressure-independent 6-way zone valve. Functional, easy to install, versatile.

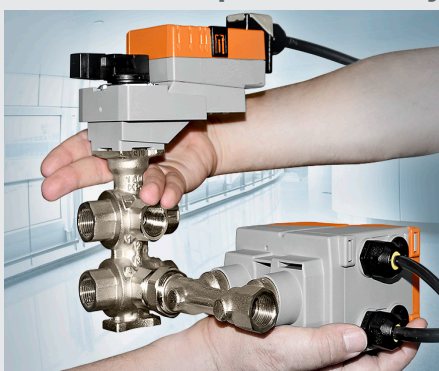

The electronic pressure-independent 6-way zone valve combines the benefits of two tried and tested Belimo valves. The good planning reliability and efficiency of the electronic pressure-independent valve (EPIV) and the ease of installation of the 6-way characterised control valve.

- Time-saving and safe valve selection in accordance with maximum volumetric flow for each sequence
- Automatic, permanent hydraulic balancing through the valve
- Securing the correct amount of water with differential pressure changes and with partial loads
- No installation errors as it is impossible to mix up the valves
- Maximum plant safety through integrated pressure relief function (patent pending)

Guidance and Legend

Guidance

Thank you for your interest in our products. In this brochure you will find information to plan your building. All Belimo products for the room and zone control are highly energy efficient, reliable and compact. They allow an optimal room climate with minimal energy expenditure.

All chapters are set as follows:

1. Circuit functions to describe the application
2. Bill of material
3. Tender specification (extended and short version)
4. Belimo – features and benefits

For further information, please do not hesitate to contact us.

Legend



Room temperature controller



Balancing valve



Temperature sensor



2-way zone valve QCV



Presence detector



3-way zone valve QCV



Window contact switch



Pressure-independent 2-way zone valve PIQCV



Dew-point sensor



6-way zone valve



Speed-controlled pump



Electronic pressure-independent 6-way zone valve

Disclaimer

Please note that the illustrations are examples only and vary depending on the type of building. Subject to modifications and amendments. Please get in touch with your Belimo contact person to verify the specifications.

	Page	
Variable-flow 2-pipe system	6	1
Self-balanced variable-flow 2-pipe system	24	2
Variable-flow 4-pipe system	42	3
Self-balanced variable-flow 4-pipe system	56	4

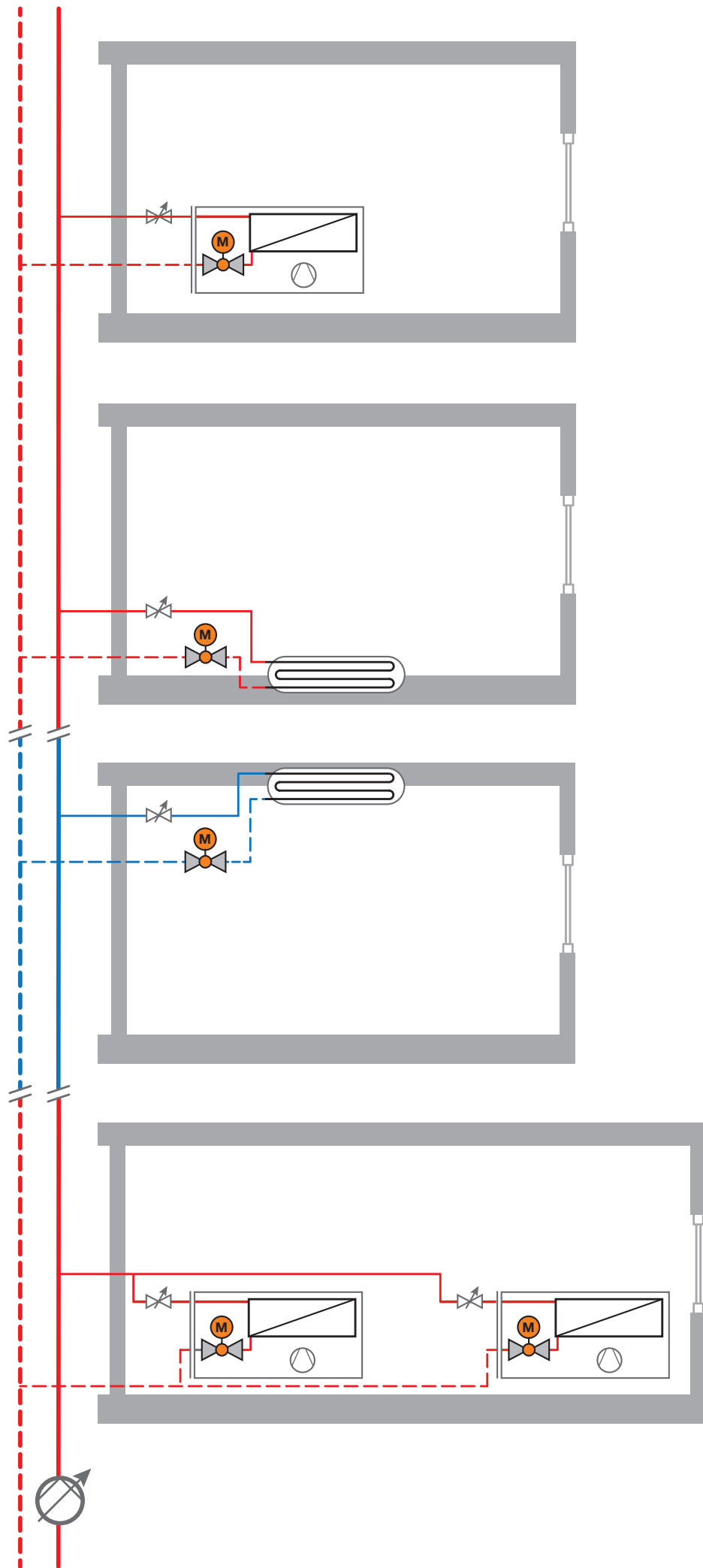

1.1 Fan coil



Example illustration

Circuit functions

- Thermal power supplied by means of fan coil
- Static hydraulic balancing (for full load) of the water flow achieved by manual balancing valve
- Pump with variable speed depending on the differential pressure in the system's most disadvantaged circuit
- Flow rate and fan speed adjusted by the room temperature controller
- Type of control of the actuator: Open-close, 3-point, modulating or Bus
- Optional functions: presence monitoring, window monitoring

Controller

Room temperature controller with:

- fan speed variation (3 speeds with 3 DO or modulating with 1 AO)
 - water flow variation with ON/OFF control, 3-points, modulating 0...10V, Bus
- Optional: Integration of signal from a presence detector and/or window contact switch

Bill of material

Typ	Description	Quantity	Costs
C2..Q..	Belimo 2-way zone valve QCV, DN .. with adjustable k_v ...-... m^3/h	1	
CQ2..	Belimo rotary actuator for zone valves, ... V, control:	1	
EXT-OC-ZR-C2..Q	Optional: Insulation for C2..Q valve, 2-way, DN ..	1	
ZR23..	Optional: Pipe connector for zone valve DN ..	2	
	Balancing valve DN ..	1	
	Work time required: Hydraulic balancing	1/2 h	
	Room temperature controller	1	
	Temperature sensor	1	
	Optional sensor: presence detector, window contact switch, ...		

Extended tender specification

Belimo QCV (Quick-Compact-Valve)

Supply and installation of 2-way valve with equal percentage characteristic curve, no leakage and high dirt-resistance.

Zone valve (characterised control valve), 2-way with internal thread.

For water-side modulating control or shut-off function in heating and air handling systems.

Snap-assembly of the actuator.

Construction type: straight way valve 2-way, DN 15 or DN 20

Connection: internal thread Rp 1/2" (DN 15) or Rp 3/4" (DN 20)

k_v -value: max. 4.8 m^3/h , adjustable (DN 15)

k_v -value: max. 8 m^3/h , adjustable (DN 20)

Media: Cold and warm water, water with glycol up to max. 50% vol.

Leakage rate A, tight (EN12266-1)

Flow characteristic: equal percentage, optimised in the opening range

Media temperature: +2...+90 °C

Permissible pressure ps: 1600 kPa

Closing pressure dps: 350 kPa

Differential pressure dpmax: 280 kPa

Housing: brass body

Closing element: chrome-plated brass

Stem: brass

Stem seal: O-ring EPDM

Valve seat: PTFE, O-ring EPDM

Manufacture: Belimo

Type: C215Q-J (DN 15)

Type: C220Q-K (DN 20)

Variable-flow 2-pipe system

Belimo actuator for QCV

Rotary actuator for zone valves.
Snap-assembly of the actuator, overload protected and without end switches, current reduction in rest position.

Torque motor: 1 Nm
Nominal voltage: AC 24 V 50/60 Hz, DC 24 V
Positioning signal: modulating DC 0...10 V
Operating range: DC 2...10 V
Power consumption:
- in operation: 0,3 W
- in rest position: 0,2 W
- for wire sizing: 0,6 VA
Connection: cable 1 m, 3 x 0.75 mm²
Actuating time: 75 s / 90°
Protection class: III Safety extra-low voltage
Degree of protection: IP40
EMC: CE according to 2004/108/EC

Manufacture: Belimo
Type: CQ24A-SR

Further types available: AC/DC 24 V, AC 230 V, open-close, 3-point, MP-Bus light, with emergency position, ...

Including electrical/mechanical connections and accessories.

5 years of product warranty

Short tender specification

Belimo QCV: 2-way zero-leaking valve with adjustable k_v setting, DN 15 or DN 20, with actuator

Belimo – features and benefits

Feature	Benefit
Compact size	Maximum efficiency in space and high design freedom
Zero-leaking valve	Circulation and energy losses are eliminated
Self-cleaning ball valve	Outstanding resistance to contamination, smooth operation even after prolonged closures
Equal percentage flow characteristic without inlet jump	Perfect controllability, even in part load situations
Variable k_v setting	High flexibility during planning, installation and use phase
Low power consumption actuator	Energy costs reduced by up to 90% compared to conventional zone valves

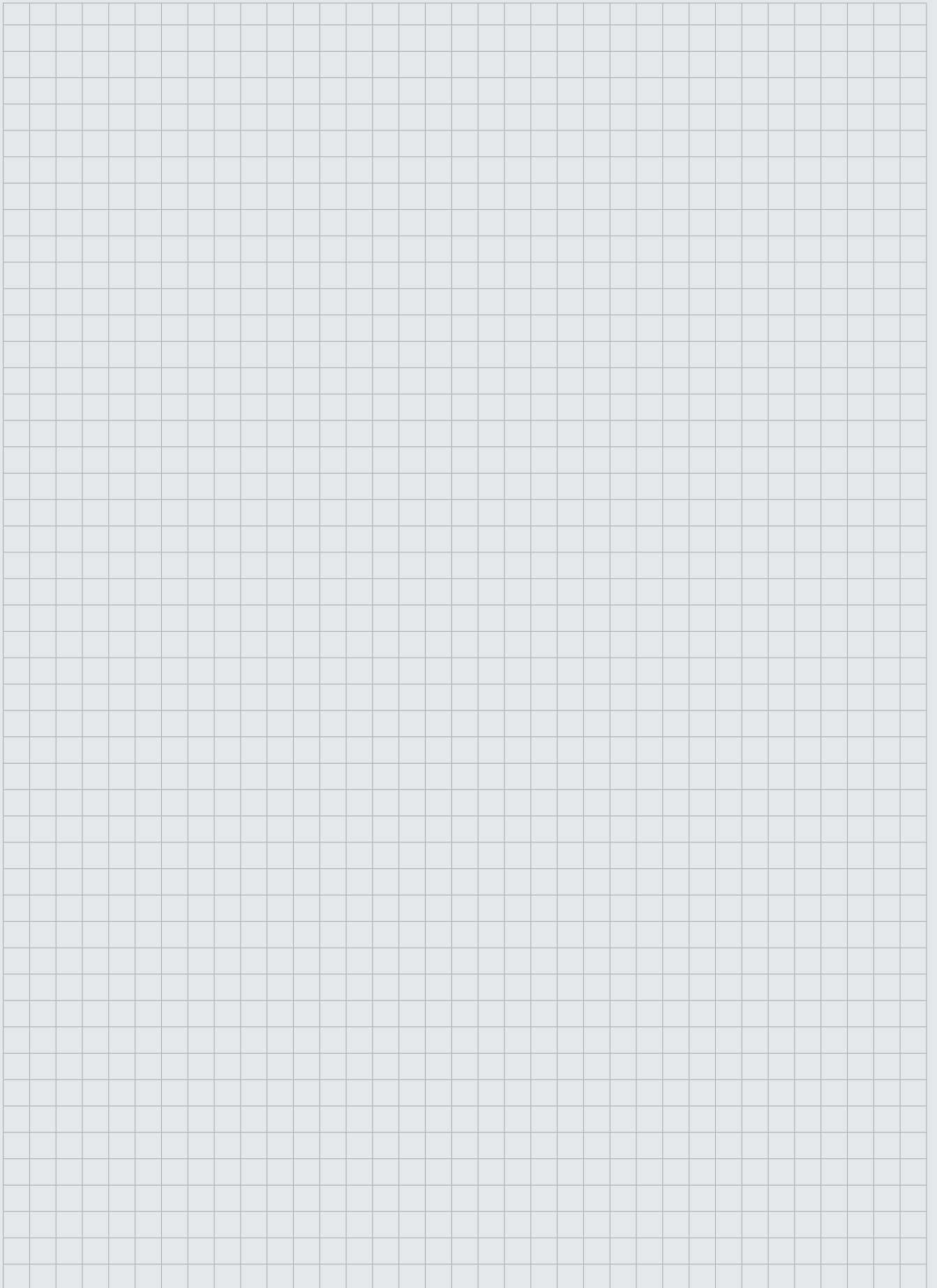

1.2 Floor heating / radiator or convection heating

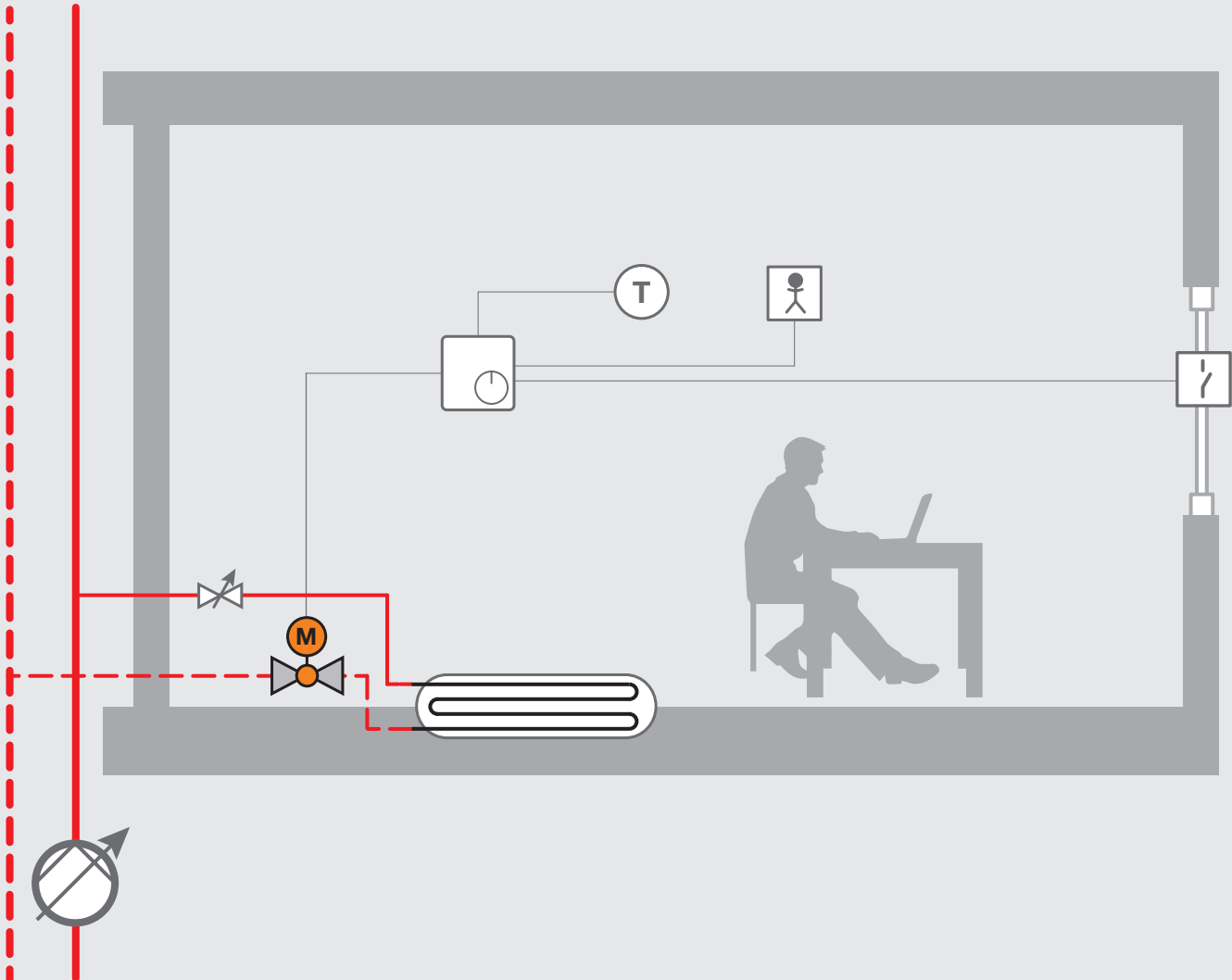

Example illustration

Circuit functions

- Thermal power supplied by means of floor-mounted or wall-mounted heating element
- Static hydraulic balancing (for full load) of the water flow achieved by manual balancing valve
- Pump with variable speed depending on the differential pressure in the system's most disadvantaged circuit
- Flow rate adjusted by the room temperature controller
- Type of control of the actuator: Open-close, 3-point, modulating or Bus
- Optional functions: presence monitoring, window monitoring

Controller

Room temperature controller with:

- water flow variation with ON/OFF control, 3-points, modulating 0...10 V, Bus
- Optional: Integration of signal from a presence detector and/or window contact switch

Bill of material

Typ	Description	Quantity	Costs
C2..Q..	Belimo 2-way zone valve QCV, DN .. with adjustable k_v ...-... m ³ /h	1	
CQ2..	Belimo rotary actuator for zone valves, ... V, control:	1	
EXT-OC-ZR-C2..Q	Optional: Insulation for C2..Q valve, 2-way, DN ..	1	
ZR23..	Optional: Pipe connector for zone valve DN ..	2	
	Balancing valve DN ..	1	
	Work time required: Hydraulic balancing	1/2 h	
	Room temperature controller	1	
	Temperature sensor	1	
	Optional sensor: presence detector, window contact switch, ...		

Extended tender specification

Belimo QCV (Quick-Compact-Valve)

Supply and installation of 2-way valve with equal percentage characteristic curve, no leakage and high dirt-resistance.

Zone valve (characterised control valve), 2-way with internal thread.

For water-side modulating control or shut-off function in heating and air handling systems.

Snap-assembly of the actuator.

Construction type: straight way valve 2-way, DN 15 or DN 20

Connection: internal thread Rp 1/2" (DN 15) or Rp 3/4" (DN 20)

k_v -value: max. 4.8 m³/h, adjustable (DN 15)

k_v -value: max. 8 m³/h, adjustable (DN 20)

Media: Cold and warm water, water with glycol up to max. 50% vol.

Leakage rate A, tight (EN12266-1)

Flow characteristic: equal percentage, optimised in the opening range

Media temperature: +2...+90 °C

Permissible pressure ps: 1600 kPa

Closing pressure dps: 350 kPa

Differential pressure dpmax: 280 kPa

Housing: brass body

Closing element: chrome-plated brass

Stem: brass

Stem seal: O-ring EPDM

Valve seat: PTFE, O-ring EPDM

Manufacture: Belimo

Type: C215Q-J (DN 15)

Type: C220Q-K (DN 20)

Variable-flow 2-pipe system

Belimo actuator for QCV

Rotary actuator for zone valves.
Snap-assembly of the actuator, overload protected and without end switches, current reduction in rest position.

Torque motor: 1 Nm
Nominal voltage: AC 24 V 50/60 Hz, DC 24 V
Positioning signal: modulating DC 0...10 V
Operating range: DC 2...10 V
Power consumption:
- in operation: 0,3 W
- in rest position: 0,2 W
- for wire sizing: 0,6 VA
Connection: cable 1 m, 3 x 0.75 mm²
Actuating time: 75 s / 90°
Protection class: III Safety extra-low voltage
Degree of protection: IP40
EMC: CE according to 2004/108/EC

Manufacture: Belimo
Type: CQ24A-SR

Further types available: AC/DC 24 V, AC 230 V, open-close, 3-point, MP-Bus light, with emergency position, ...

Including electrical/mechanical connections and accessories.

5 years of product warranty

Short tender specification

Belimo QCV: 2-way zero-leaking valve with adjustable k_v setting, DN 15 or DN 20, with actuator

Belimo – features and benefits

Feature	Benefit
Compact size	Maximum efficiency in space and high design freedom
Zero-leaking valve	Circulation and energy losses are eliminated
Self-cleaning ball valve	Outstanding resistance to contamination, smooth operation even after prolonged closures
Equal percentage flow characteristic without inlet jump	Perfect controllability, even in part load situations
Variable k_v setting	High flexibility during planning, installation and use phase
Low power consumption actuator	Energy costs reduced by up to 90% compared to conventional zone valves

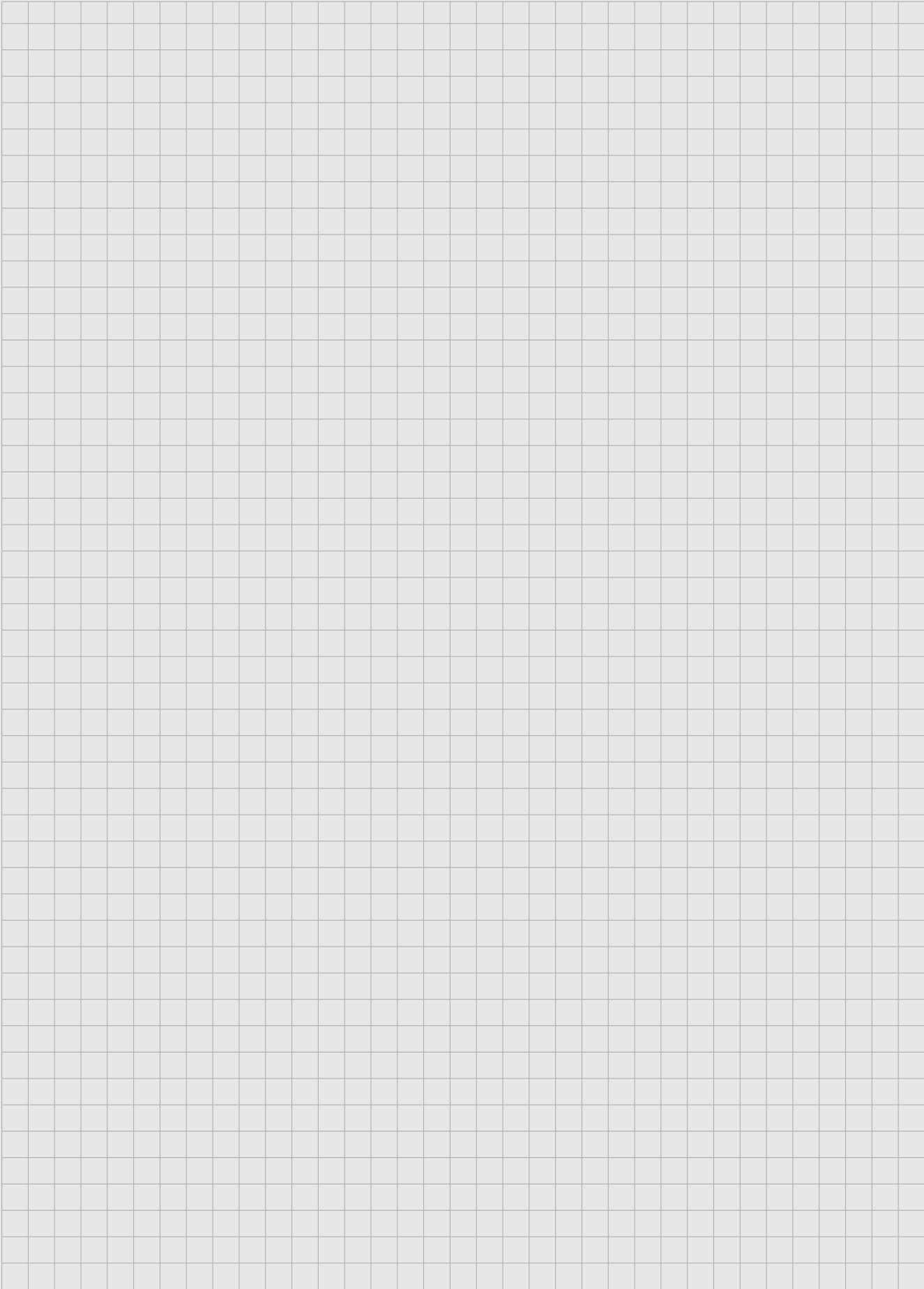

1.3 Cooling ceiling

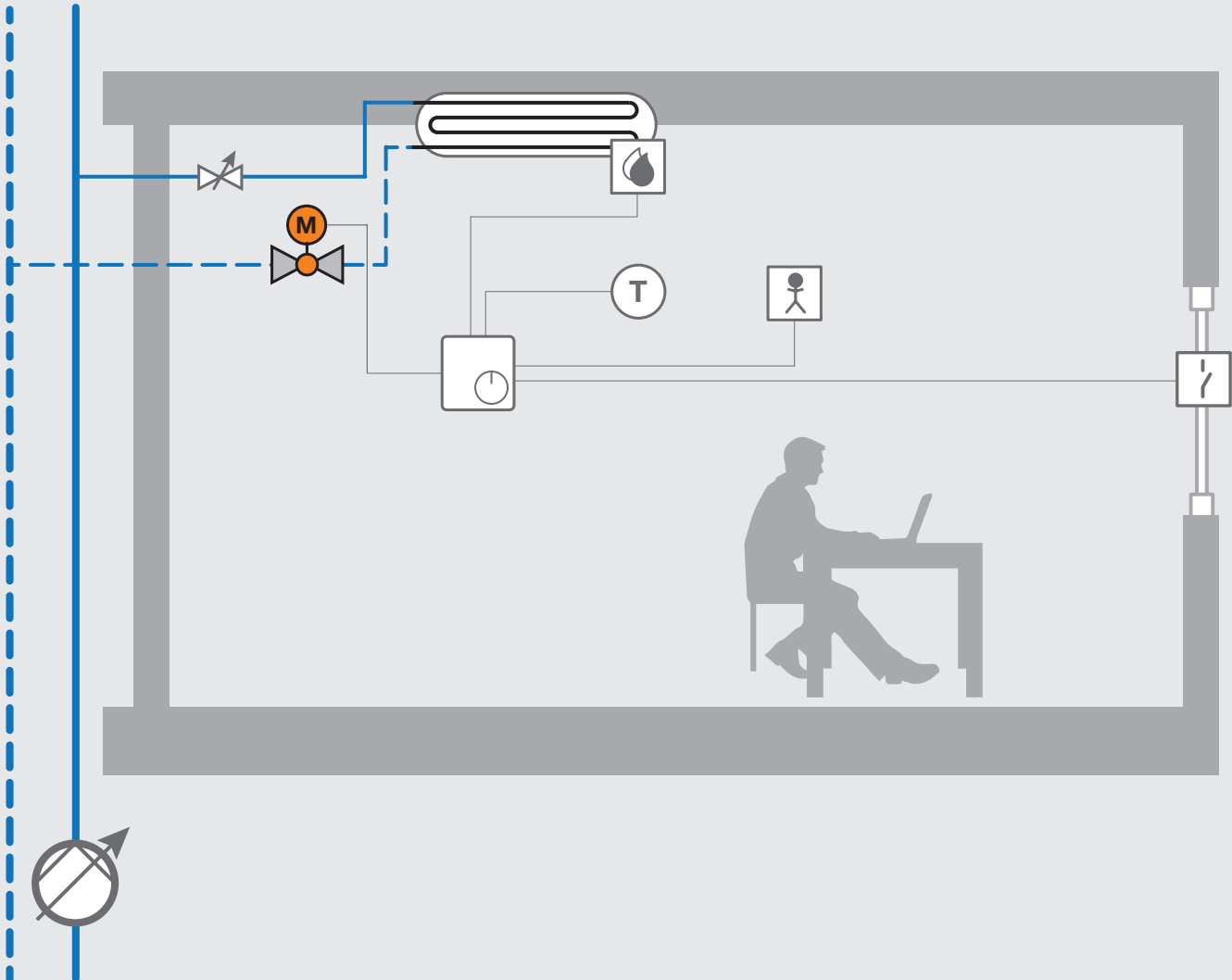

Example illustration

Circuit functions

- Thermal power supplied by chilled ceiling (additional heating possibility with centralised change-over)
- Static hydraulic balancing (for full load) of the water flow achieved by manual balancing valve
- Pump with variable speed depending on the differential pressure in the system's most disadvantaged circuit
- Flow rate adjusted by the room temperature controller
- Automatic shut-off if the temperature falls below the dew point
- Automatic shut-off in the event of an open window
- Type of control of the actuator: Open-close, 3-point, modulating or Bus
- Optional functions: presence monitoring

Controller

Room temperature controller with:

- water flow variation with ON/OFF control, 3-points, modulating 0...10 V, Bus
- valve shut-off upon signal from dew-point sensor
- valve shut-off upon window contact signal

Optional: Integration of signal from a presence detector

Bill of material

Typ	Description	Quantity	Costs
C2..Q..	Belimo 2-way zone valve QCV, DN .. with adjustable k_v ...-... m^3/h	1	
CQ2..	Belimo rotary actuator for zone valves, ... V, control:	1	
ZCQ-W	Optional: Housing cover CQ white	1	
ZR23..	Optional: Pipe connector for zone valve DN ..	2	
ZCQ-E	Optional: Spindle extension CQ (for cooling applications)	1	
	Balancing valve DN ..	1	
	Work time required: Hydraulic balancing	1/2 h	
	Room temperature controller	1	
	Temperature sensor	1	
	Dew-point sensor	1	
	Windows contact switch	1	
	Optional sensor: presence detector		

Extended tender specification

Belimo QCV (Quick-Compact-Valve)

Supply and installation of 2-way valve with equal percentage characteristic curve, no leakage and high dirt-resistance.

Zone valve (characterised control valve), 2-way with internal thread.

For water-side modulating control or shut-off function in heating and air handling systems.

Snap-assembly of the actuator.

Construction type: straight way valve 2-way, DN 15 or DN 20

Connection: internal thread Rp 1/2" (DN 15) or Rp 3/4" (DN 20)

k_v -value: max. 4.8 m^3/h , adjustable (DN 15)

k_v -value: max. 8 m^3/h , adjustable (DN 20)

Media: Cold and warm water, water with glycol up to max. 50% vol.

Leakage rate A, tight (EN12266-1)

Flow characteristic: equal percentage, optimised in the opening range

Media temperature: +2...+90 °C

Permissible pressure ps: 1600 kPa

Closing pressure dps: 350 kPa

Differential pressure dpmax: 280 kPa

Housing: brass body

Closing element: chrome-plated brass

Stem: brass

Stem seal: O-ring EPDM

Valve seat: PTFE, O-ring EPDM

Manufacture: Belimo

Type: C215Q-J (DN 15)

Type: C220Q-K (DN 20)

Variable-flow 2-pipe system

Belimo actuator for QCV

Rotary actuator for zone valves.
Snap-assembly of the actuator, overload protected and without end switches, current reduction in rest position.

Torque motor: 1 Nm
Nominal voltage: AC 24 V 50/60 Hz, DC 24 V
Positioning signal: modulating DC 0...10 V
Operating range: DC 2...10 V
Power consumption:
- in operation: 0,3 W
- in rest position: 0,2 W
- for wire sizing: 0,6 VA
Connection: cable 1 m, 3 x 0.75 mm²
Actuating time: 75 s / 90°
Protection class: III Safety extra-low voltage
Degree of protection: IP40
EMC: CE according to 2004/108/EC

Manufacture: Belimo
Type: CQ24A-SR

Further types available: AC/DC 24 V, AC 230 V, open-close, 3-point, MP-Bus light, with emergency position, ...

Including electrical/mechanical connections and accessories.

5 years of product warranty

Short tender specification

Belimo QCV: 2-way zero-leaking valve with adjustable k_v setting, DN 15 or DN 20, with actuator

Belimo – features and benefits

Feature	Benefit
Compact size	Maximum efficiency in space and high design freedom
Zero-leaking valve	Circulation and energy losses are eliminated
Self-cleaning ball valve	Outstanding resistance to contamination, smooth operation even after prolonged closures
Equal percentage flow characteristic without inlet jump	Perfect controllability, even in part load situations
Variable k_v setting	High flexibility during planning, installation and use phase
Low power consumption actuator	Energy costs reduced by up to 90% compared to conventional zone valves

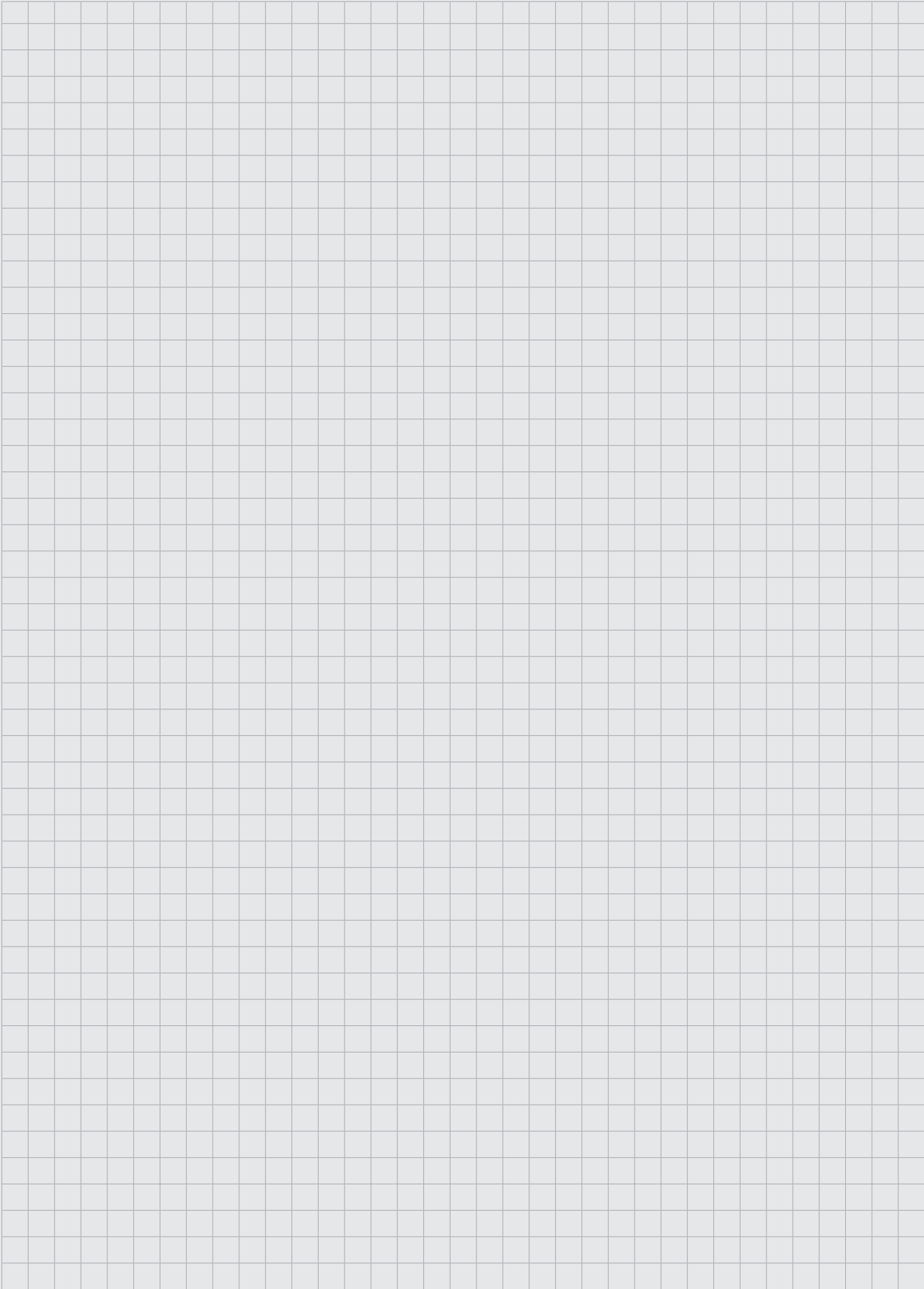

1.4 Several fan coils

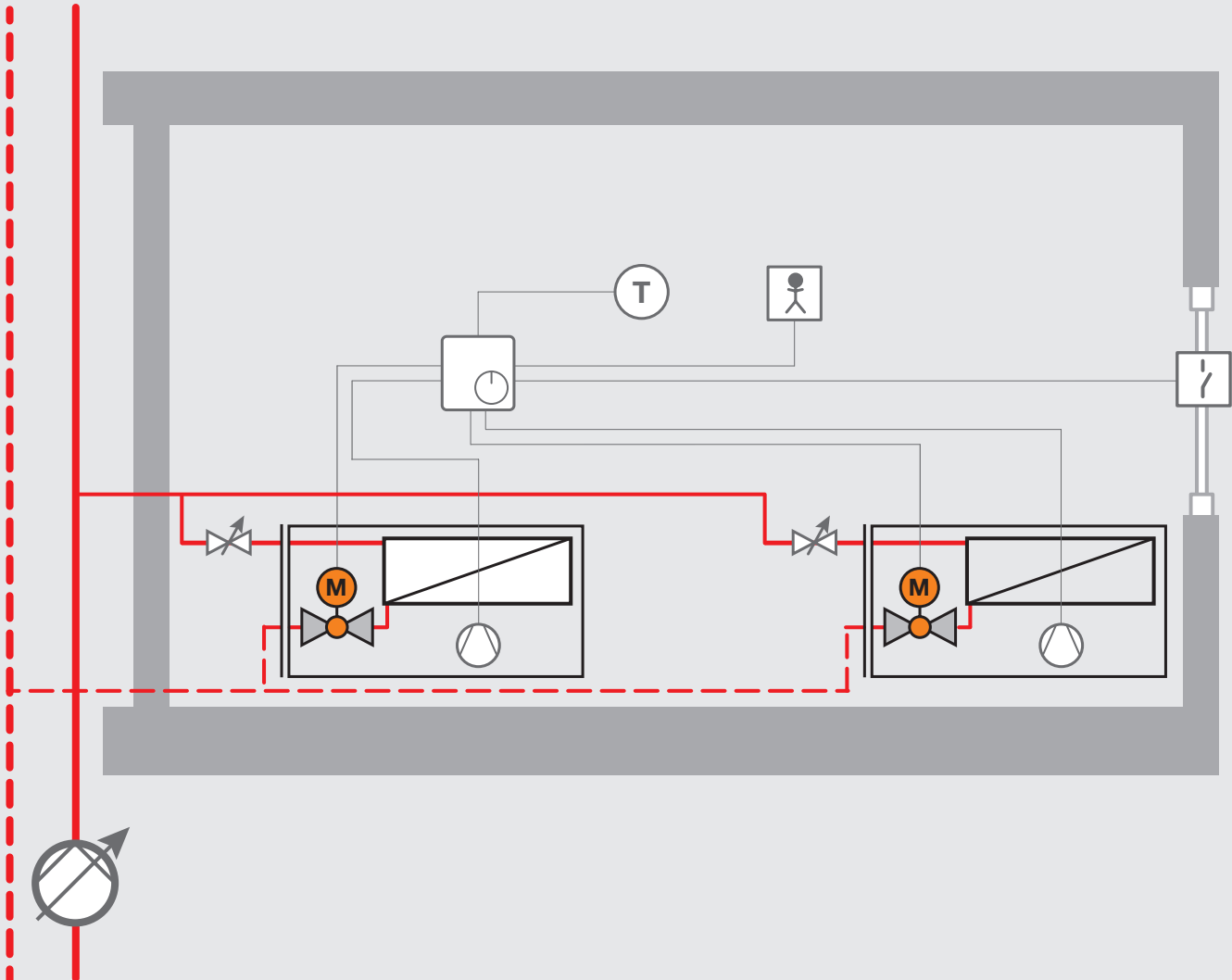

Example illustration

Circuit functions

- Thermal power supplied by means of fan coils
- Static hydraulic balancing (for full load) of the water flow achieved by manual balancing valves
- Pump with variable speed depending on the differential pressure in the system's most disadvantaged circuit
- Flow rates and fan speeds adjusted by one room temperature controller
- Type of control of the actuator: Open-close, 3-point, modulating or Bus
- Optional functions: presence monitoring, window monitoring

Controller

Room temperature controller with:

- fan speed variation (3 speeds with 3 DO or modulating with 1 AO)
 - water flow variation with ON/OFF control, 3-points, modulating 0...10 V, Bus
- Optional: Integration of signal from a presence detector and/or window contact switch

Bill of material

Typ	Description	Quantity	Costs
C2..Q..	Belimo 2-way zone valve QCV, DN .. with adjustable k_v ...-... m^3/h	(*)	
CQ2..	Belimo rotary actuator for zone valves, ... V, control:	(*)	
EXT-OC-ZR-C2..Q	Optional: Insulation for C2..Q valve, 2-way, DN ..	(*)	
ZR23..	Optional: Pipe connector for zone valve DN ..	(*) x 2	
	Balancing valve DN ..	(*)	
	Work time required: Hydraulic balancing	(*) x 1/2 h	
	Room temperature controller	1	
	Temperature sensor	1	
	Optional sensor: presence detector, window contact switch, ...		

(*) Possibility of controlling several fan coils with one room temperature controller. The maximum number of controllable terminal devices is dependent on the room temperature controller.

Extended tender specification

Belimo QCV (Quick-Compact-Valve)

Supply and installation of 2-way valve with equal percentage characteristic curve, no leakage and high dirt-resistance.

Zone valve (characterised control valve), 2-way with internal thread.

For water-side modulating control or shut-off function in heating and air handling systems.

Snap-assembly of the actuator.

Construction type: straight way valve 2-way, DN 15 or DN 20

Connection: internal thread Rp 1/2" (DN 15) or Rp 3/4" (DN 20)

k_v -value: max. 4.8 m^3/h , adjustable (DN 15)

k_v -value: max. 8 m^3/h , adjustable (DN 20)

Media: Cold and warm water, water with glycol up to max. 50% vol.

Leakage rate A, tight (EN12266-1)

Flow characteristic: equal percentage, optimised in the opening range

Media temperature: +2...+90 °C

Permissible pressure ps: 1600 kPa

Closing pressure dps: 350 kPa

Differential pressure dpmax: 280 kPa

Housing: brass body

Closing element: chrome-plated brass

Stem: brass

Stem seal: O-ring EPDM

Valve seat: PTFE, O-ring EPDM

Manufacture: Belimo

Type: C215Q-J (DN 15)

Type: C220Q-K (DN 20)

Variable-flow 2-pipe system

Belimo actuator for QCV

Rotary actuator for zone valves.
Snap-assembly of the actuator, overload protected and without end switches, current reduction in rest position.

Torque motor: 1 Nm
Nominal voltage: AC 24 V 50/60 Hz, DC 24 V
Positioning signal: modulating DC 0...10 V
Operating range: DC 2...10 V
Power consumption:
- in operation: 0,3 W
- in rest position: 0,2 W
- for wire sizing: 0,6 VA
Connection: cable 1 m, 3 x 0.75 mm²
Actuating time: 75 s / 90°
Protection class: III Safety extra-low voltage
Degree of protection: IP40
EMC: CE according to 2004/108/EC

Manufacture: Belimo
Type: CQ24A-SR

Further types available: AC/DC 24 V, AC 230 V, open-close, 3-point, MP-Bus light, with emergency position, ...

Including electrical/mechanical connections and accessories.

5 years of product warranty

Short tender specification

Belimo QCV: 2-way zero-leaking valve with adjustable k_v setting, DN 15 or DN 20, with actuator

Belimo – features and benefits

Feature	Benefit
Compact size	Maximum efficiency in space and high design freedom
Zero-leaking valve	Circulation and energy losses are eliminated
Self-cleaning ball valve	Outstanding resistance to contamination, smooth operation even after prolonged closures
Equal percentage flow characteristic without inlet jump	Perfect controllability, even in part load situations
Variable k_v setting	High flexibility during planning, installation and use phase
Low power consumption actuator	Energy costs reduced by up to 90% compared to conventional zone valves

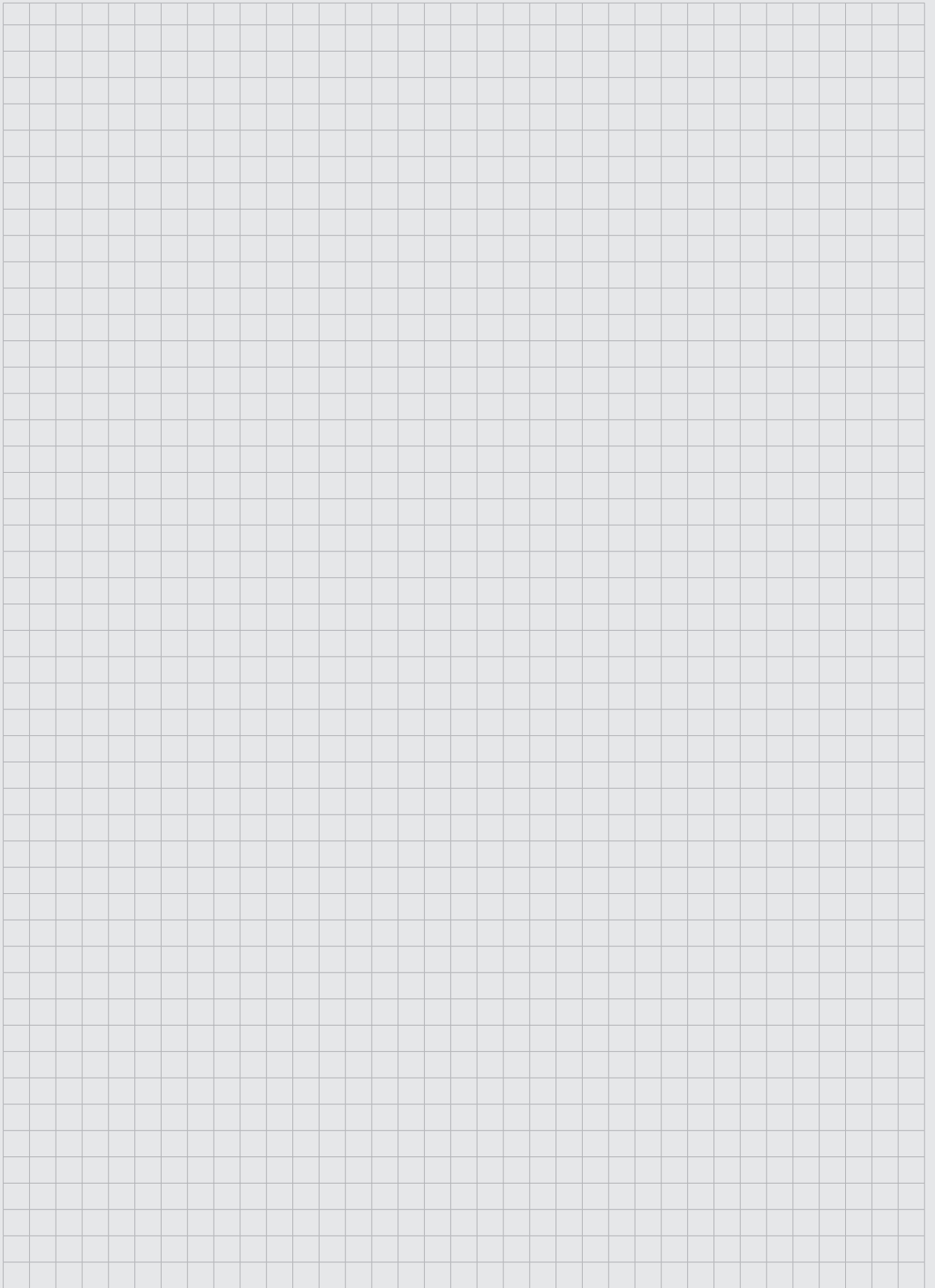

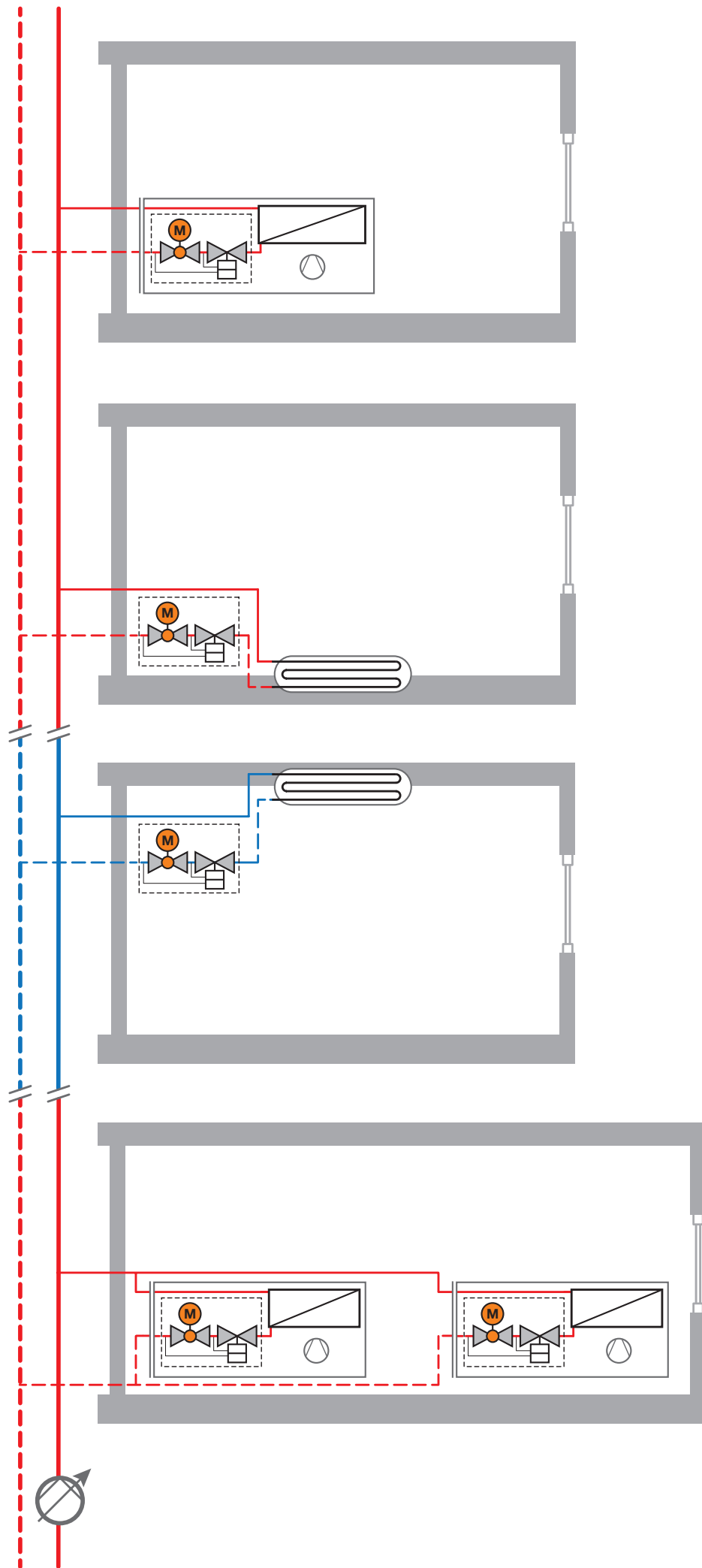

2

Self-balanced variable-flow 2-pipe system

2

	2.1	Fan coil	26
Self-balanced variable-flow 2-pipe system	2.2	Floor heating / radiator or convection heating	30
	2.3	Cooling ceiling	34
	2.4	Several fan coils	38



2.1 Fan coil

Self-balanced variable-flow 2-pipe system

2

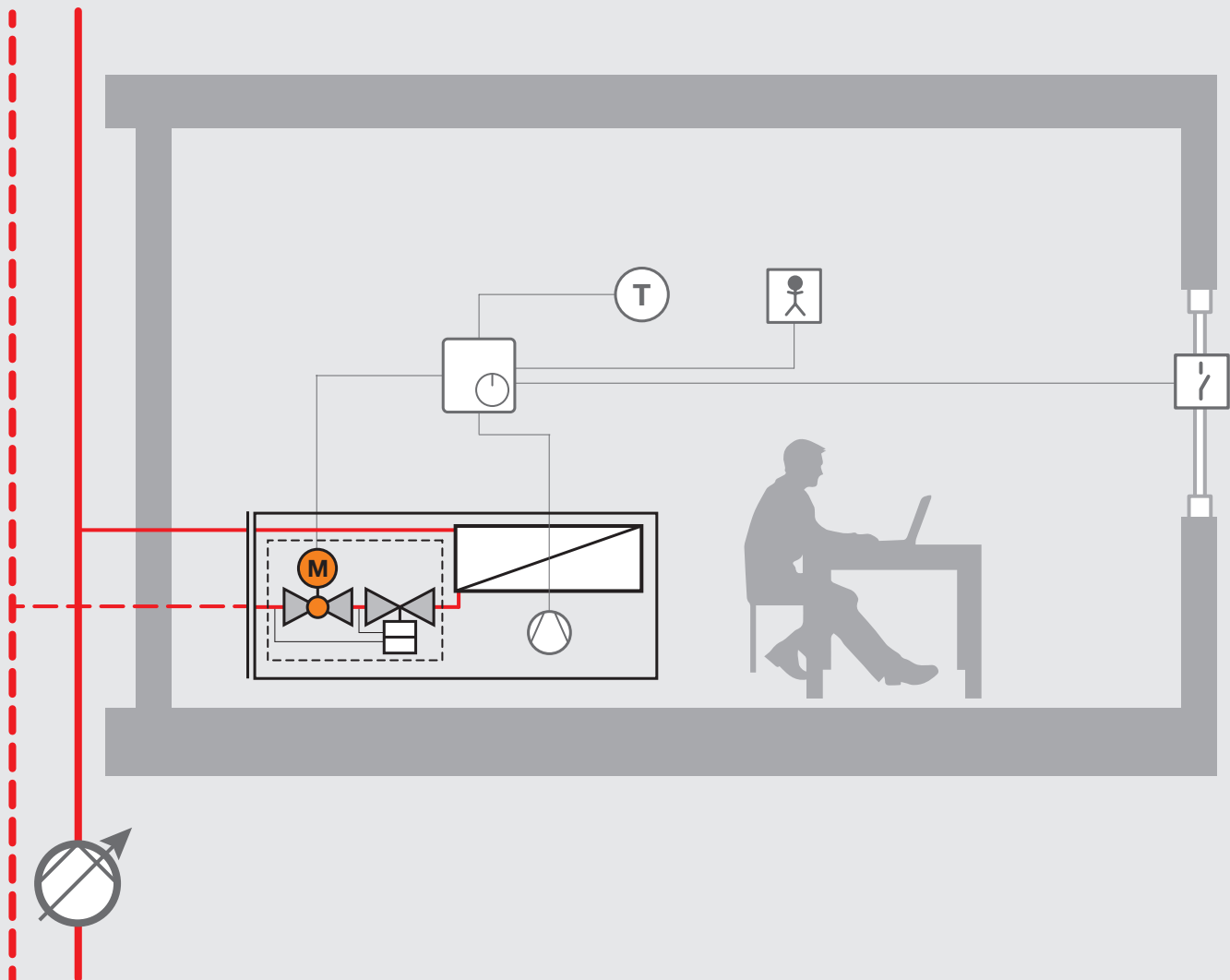

Example illustration

Circuit functions

- Thermal power supplied by means of fan coil
- Permanent hydraulic balancing (in any load condition) of the water flow achieved by the pressure-independent control valve
- Pump with variable speed depending on the differential pressure in the system's most disadvantaged circuit
- Flow rate and fan speed adjusted by the room temperature controller
- Type of control of the actuator: Open-close, 3-point, modulating or Bus
- Optional functions: presence monitoring, window monitoring

Controller

Room temperature controller with:

- fan speed variation (3 speeds with 3 DO or modulating with 1 AO)
 - water flow variation with ON/OFF control, 3-points, modulating 0...10 V, Bus
- Optional: Integration of signal from a presence detector and/or window contact switch

Bill of material

Typ	Description	Quantity	Costs
C2..QP(T)-..	Belimo pressure-independent 2-way zone valve PIQCV, DN .. with adjustable V'_{max} ...-... l/h	1	
CQ2..	Belimo rotary actuator for zone valves, ... V, control:	1	
EXT-OC-ZQ..-P(T)	Optional: Insulation for C2..QP(T) valve, 2-way, DN ..	1	
ZR23..	Optional: Pipe connector for zone valve DN ..	2	
	Room temperature controller	1	
	Temperature sensor	1	
	Optional sensor: presence detector, window contact switch, ...		

Extended tender specification

Belimo PIQCV (Pressure-Independent-Quick-Compact-Valve)

Supply and installation of pressure-independent 2-way valve with automatic permanent hydraulic balancing, equal percentage characteristic curve, no leakage and high dirt-resistance.

Pressure independent zone valve (characterised control valve), 2-way with internal thread.

For water-side modulating control in heating and air handling systems.

Snap-assembly of the actuator, pressure-reducing valve for constant flow rate independently from pressure variations.

With measuring ports for verification of pressure value (optional version).

Construction type: straight way valve 2-way, DN 15 or DN 20

Connection: internal thread Rp 1/2" (DN 15) or Rp 3/4" (DN 20)

Flow rate V_{max} : max. 210 l/h, adjustable [C215QP(T)-B]

Flow rate V_{max} : max. 420 l/h, adjustable [C215QP(T)-D]

Flow rate V_{max} : max. 980 l/h, adjustable [C220QP(T)-F]

Media: Cold and warm water, water with glycol up to max. 50% vol.

Leakage rate A, tight (EN12266-1)

Flow characteristic: equal percentage (VDI/VDE 2178), optimised in the opening range

Media temperature: +2...+90 °C

Permissible pressure ps: 1600 kPa

Closing pressure dps: 700 kPa

Pressure value: 16...350 kPa

Housing: brass body

Closing element: stainless steel

Stem: stainless steel

Stem seal: O-ring EPDM

Valve seat: PTFE, O-ring EPDM

Diaphragm: EPDM

Manufacture: Belimo

Type: C215QP(T)-B (DN 15, 210 l/h)

Type: C215QP(T)-D (DN 15, 420 l/h)

Type: C220QP(T)-F (DN 20, 980 l/h)

(T) = Version with measuring ports

Self-balanced variable-flow 2-pipe system

Belimo actuator for (PI)QCV

Rotary actuator for zone valves.
Snap-assembly of the actuator, overload protected and without end switches, current reduction in rest position.

Torque motor: 1 Nm
Nominal voltage: AC 24 V 50/60 Hz, DC 24 V
Positioning signal: modulating DC 0...10 V
Operating range: DC 2...10 V
Power consumption:
- in operation: 0,3 W
- in rest position: 0,2 W
- for wire sizing: 0,6 VA
Connection: cable 1 m, 3 x 0.75 mm²
Actuating time: 75 s / 90°
Protection class: III Safety extra-low voltage
Degree of protection: IP40
EMC: CE according to 2004/108/EC

Manufacture: Belimo
Type: CQ24A-SR

Further types available: AC/DC 24 V, AC 230 V, open-close, 3-point, MP-Bus light, with emergency position, ...

Including electrical/mechanical connections and accessories.

5 years of product warranty

Short tender specification

Belimo PIQCV: pressure-independent 2-way zero-leaking valve with adjustable flow rate setting, DN 15 or DN 20, with actuator

Belimo – features and benefits

Feature	Benefit
Pressure-independent	Quick and safe valve selection according to flow rate, no calculation of k_v
	Ideal room comfort due to correct flow rate at any time
Automatic and permanent hydraulic balancing	Fast commissioning, no balancing valves needed
Compact size	Maximum efficiency in space and high design freedom
Zero-leaking valve	Circulation and energy losses are eliminated
Self-cleaning ball valve	Outstanding resistance to contamination, smooth operation even after prolonged closures
Equal percentage flow characteristic without inlet jump	Perfect controllability, even in part load situations
Variable V'_{max} setting	Highest flexibility during planning, installation and use phase
Low power consumption actuator	Energy costs reduced by up to 90% compared to conventional zone valves

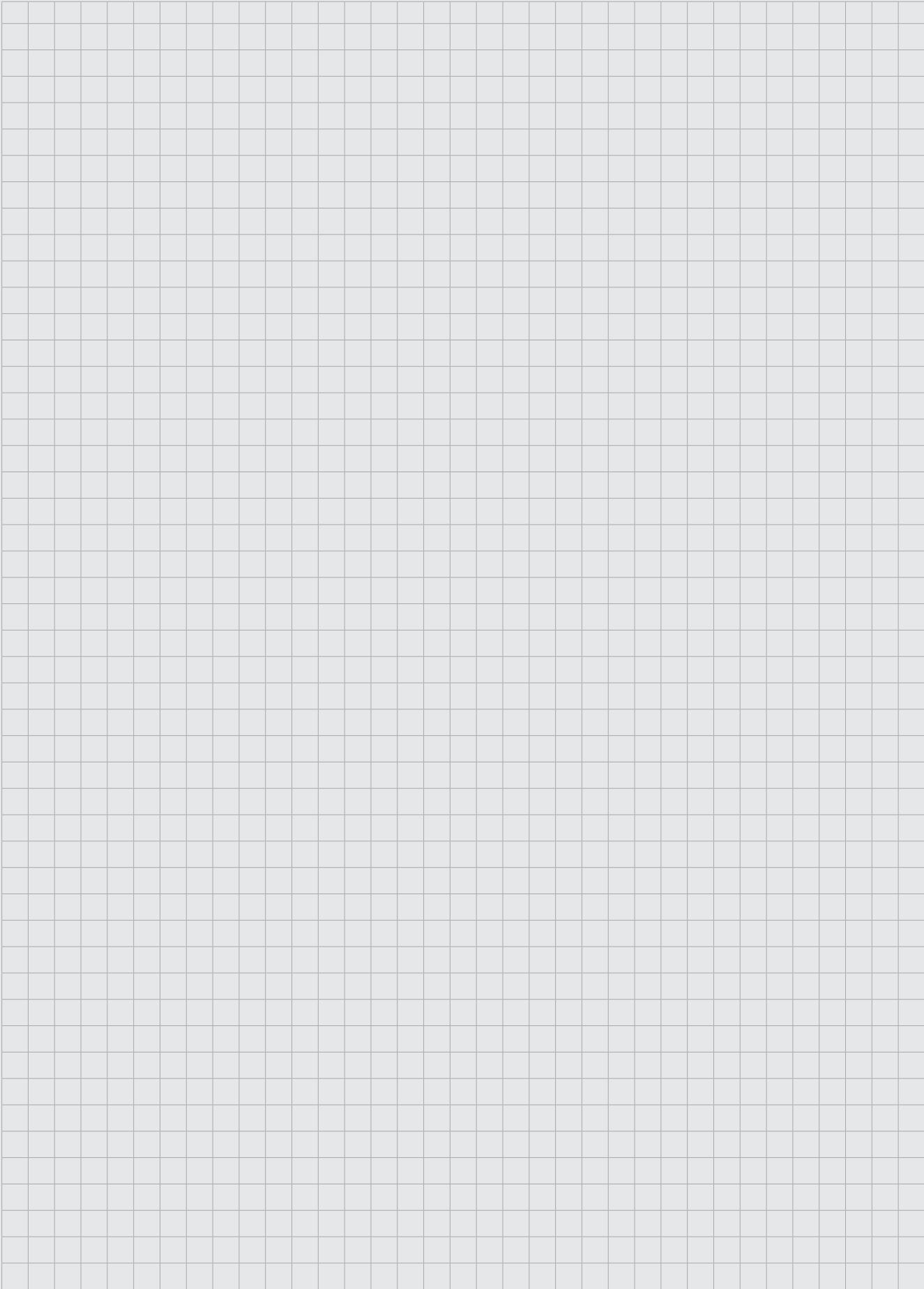

2.2 Floor heating / radiator or convection heating

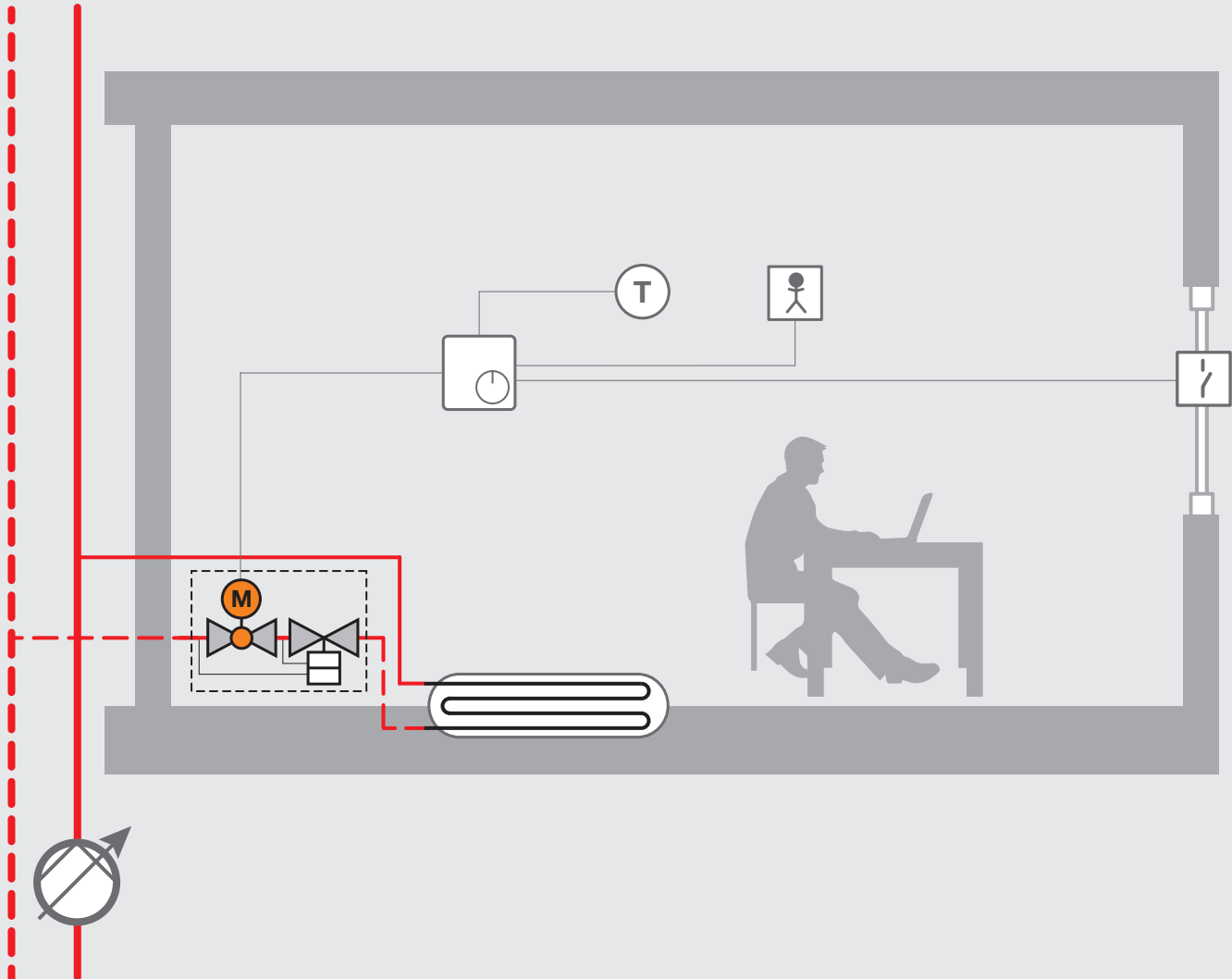

Example illustration

Circuit functions

- Thermal power supplied by means of floor-mounted or wall-mounted heating element
- Permanent hydraulic balancing (in any load condition) of the water flow achieved by the pressure-independent control valve
- Pump with variable speed depending on the differential pressure in the system's most disadvantaged circuit
- Flow rate adjusted by the room temperature controller
- Type of control of the actuator: Open-close, 3-point, modulating or Bus
- Optional functions: presence monitoring, window monitoring

Controller

Room temperature controller with:

- water flow variation with ON/OFF control, 3-points, modulating 0...10 V, Bus
- Optional: Integration of signal from a presence detector and/or window contact switch

Bill of material

Typ	Description	Quantity	Costs
C2..QP(T)-..	Belimo pressure-independent 2-way zone valve PIQCV, DN .. with adjustable V_{max} ...-... l/h	1	
CQ2..	Belimo rotary actuator for zone valves, ... V, control:	1	
EXT-OC-ZQ..-P(T)	Optional: Insulation for C2..QP(T) valve, 2-way, DN ..	1	
ZR23..	Optional: Pipe connector for zone valve DN ..	2	
	Room temperature controller	1	
	Temperature sensor	1	
	Optional sensor: presence detector, window contact switch, ...		

Extended tender specification

Belimo PIQCV (Pressure-Independent-Quick-Compact-Valve)

Supply and installation of pressure-independent 2-way valve with automatic permanent hydraulic balancing, equal percentage characteristic curve, no leakage and high dirt-resistance.

Pressure independent zone valve (characterised control valve), 2-way with internal thread.

For water-side modulating control in heating and air handling systems.

Snap-assembly of the actuator, pressure-reducing valve for constant flow rate independently from pressure variations.

With measuring ports for verification of pressure value (optional version).

Construction type: straight way valve 2-way, DN 15 or DN 20

Connection: internal thread Rp 1/2" (DN 15) or Rp 3/4" (DN 20)

Flow rate V_{max} : max. 210 l/h, adjustable [C215QP(T)-B]

Flow rate V_{max} : max. 420 l/h, adjustable [C215QP(T)-D]

Flow rate V_{max} : max. 980 l/h, adjustable [C220QP(T)-F]

Media: Cold and warm water, water with glycol up to max. 50% vol.

Leakage rate A, tight (EN12266-1)

Flow characteristic: equal percentage (VDI/VDE 2178), optimised in the opening range

Media temperature: +2...+90 °C

Permissible pressure ps: 1600 kPa

Closing pressure dps: 700 kPa

Pressure value: 16...350 kPa

Housing: brass body

Closing element: stainless steel

Stem: stainless steel

Stem seal: O-ring EPDM

Valve seat: PTFE, O-ring EPDM

Diaphragm: EPDM

Manufacture: Belimo

Type: C215QP(T)-B (DN 15, 210 l/h)

Type: C215QP(T)-D (DN 15, 420 l/h)

Type: C220QP(T)-F (DN 20, 980 l/h)

(T) = Version with measuring ports

Self-balanced variable-flow 2-pipe system

Belimo actuator for (PI)QCV

Rotary actuator for zone valves.
Snap-assembly of the actuator, overload protected and without end switches, current reduction in rest position.

Torque motor: 1 Nm
Nominal voltage: AC 24 V 50/60 Hz, DC 24 V
Positioning signal: modulating DC 0...10 V
Operating range: DC 2...10 V
Power consumption:
- in operation: 0,3 W
- in rest position: 0,2 W
- for wire sizing: 0,6 VA
Connection: cable 1 m, 3 x 0.75 mm²
Actuating time: 75 s / 90°
Protection class: III Safety extra-low voltage
Degree of protection: IP40
EMC: CE according to 2004/108/EC

Manufacture: Belimo
Type: CQ24A-SR

Further types available: AC/DC 24 V, AC 230 V, open-close, 3-point, MP-Bus light, with emergency position, ...

Including electrical/mechanical connections and accessories.

5 years of product warranty

Short tender specification

Belimo PIQCV: pressure-independent 2-way zero-leaking valve with adjustable flow rate setting, DN 15 or DN 20, with actuator

Belimo – features and benefits

Feature	Benefit
Pressure-independent	Quick and safe valve selection according to flow rate, no calculation of k_v
	Ideal room comfort due to correct flow rate at any time
Automatic and permanent hydraulic balancing	Fast commissioning, no balancing valves needed
Compact size	Maximum efficiency in space and high design freedom
Zero-leaking valve	Circulation and energy losses are eliminated
Self-cleaning ball valve	Outstanding resistance to contamination, smooth operation even after prolonged closures
Equal percentage flow characteristic without inlet jump	Perfect controllability, even in part load situations
Variable V'_{max} setting	Highest flexibility during planning, installation and use phase
Low power consumption actuator	Energy costs reduced by up to 90% compared to conventional zone valves

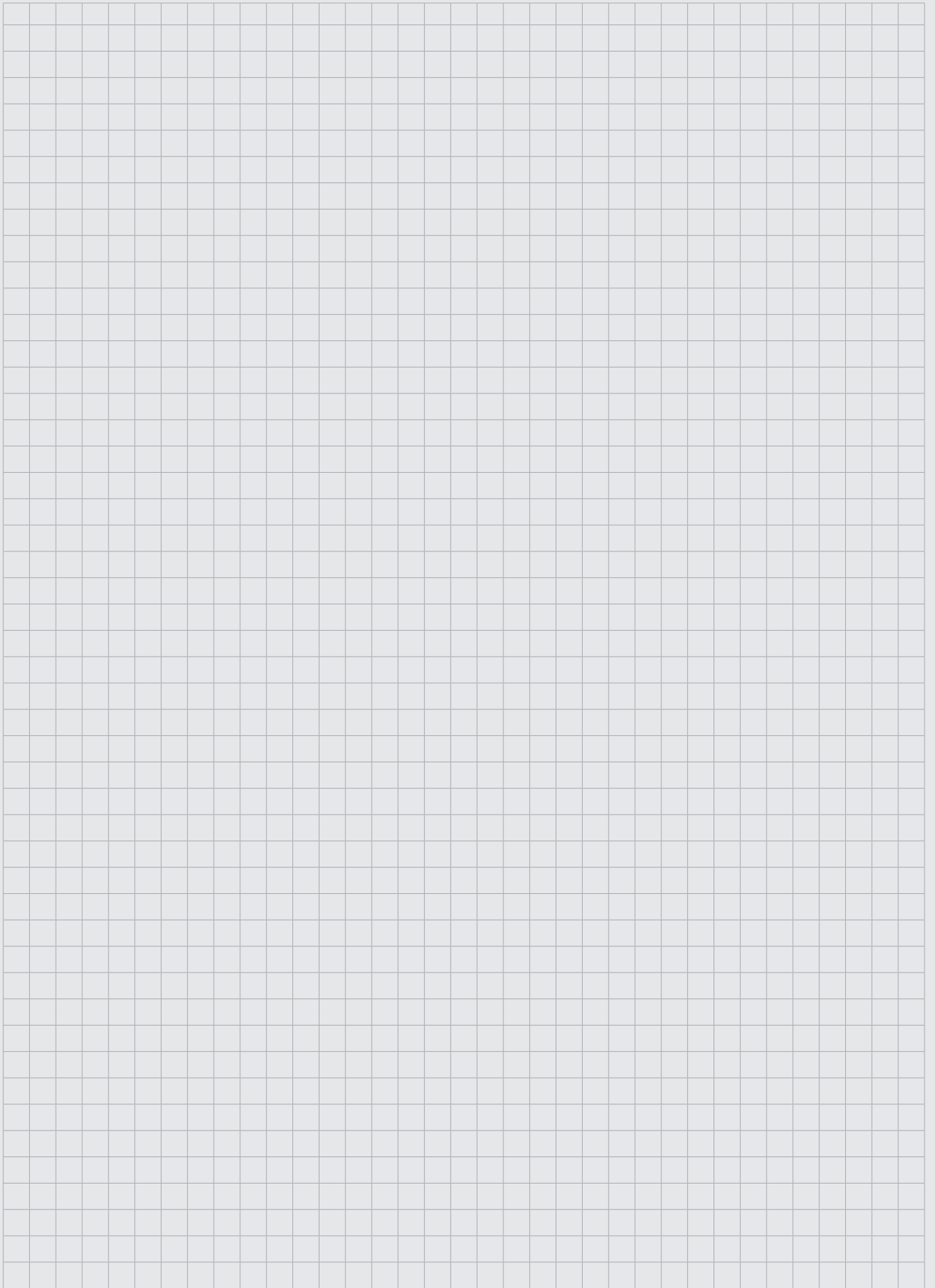

2.3 Cooling ceiling

Self-balanced variable-flow 2-pipe system

2

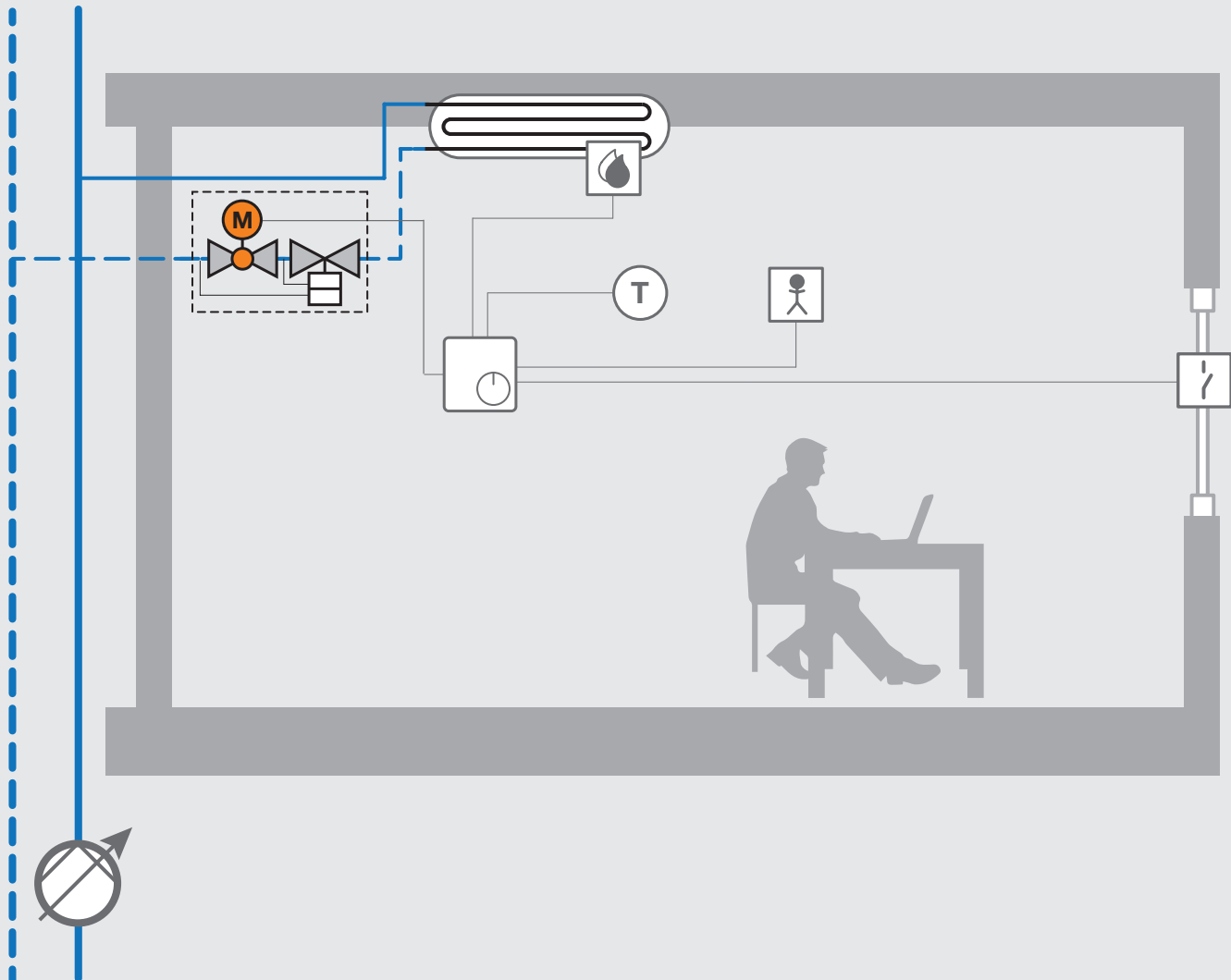

Example illustration

Circuit functions

- Thermal power supplied by chilled ceiling (additional heating possibility with centralised change-over)
- Permanent hydraulic balancing (in any load condition) of the water flow achieved by the pressure-independent control valve
- Pump with variable speed depending on the differential pressure in the system's most disadvantaged circuit
- Flow rate adjusted by the room temperature controller
- Automatic shut-off if the temperature falls below the dew point
- Automatic shut-off in the event of an open window
- Type of control of the actuator: Open-close, 3-point, modulating or Bus
- Optional functions: presence monitoring

Controller

Room temperature controller with:

- water flow variation with ON/OFF control, 3-points, modulating 0...10 V, Bus
- valve shut-off upon signal from dew-point sensor
- valve shut-off upon window contact signal

Optional: Integration of signal from a presence detector

Bill of material

Typ	Description	Quantity	Costs
C2..QP(T)-..	Belimo pressure-independent 2-way zone valve PIQCV, DN .. with adjustable V'_{max} ...-... l/h	1	
CQ2..	Belimo rotary actuator for zone valves, ... V, control:	1	
ZCQ-W	Optional: Housing cover CQ white	1	
ZR23..	Optional: Pipe connector for zone valve DN ..	2	
ZCQ-E	Optional: Spindle extension CQ (for cooling applications)	1	
	Room temperature controller	1	
	Temperature sensor	1	
	Dew-point sensor	1	
	Windows contact switch	1	
	Optional sensor: presence detector		

Extended tender specification

Belimo PIQCV (Pressure-Independent-Quick-Compact-Valve)

Supply and installation of pressure-independent 2-way valve with automatic permanent hydraulic balancing, equal percentage characteristic curve, no leakage and high dirt-resistance.

Pressure independent zone valve (characterised control valve), 2-way with internal thread.

For water-side modulating control in heating and air handling systems.

Snap-assembly of the actuator, pressure-reducing valve for constant flow rate independently from pressure variations.

With measuring ports for verification of pressure value (optional version).

Construction type: straight way valve 2-way, DN 15 or DN 20

Connection: internal thread Rp 1/2" (DN 15) or Rp 3/4" (DN 20)

Flow rate V_{max} : max. 210 l/h, adjustable [C215QP(T)-B]

Flow rate V_{max} : max. 420 l/h, adjustable [C215QP(T)-D]

Flow rate V_{max} : max. 980 l/h, adjustable [C220QP(T)-F]

Media: Cold and warm water, water with glycol up to max. 50% vol.

Leakage rate A, tight (EN12266-1)

Flow characteristic: equal percentage (VDI/VDE 2178), optimised in the opening range

Media temperature: +2...+90 °C

Permissible pressure ps: 1600 kPa

Closing pressure dps: 700 kPa

Pressure value: 16...350 kPa

Housing: brass body

Closing element: stainless steel

Stem: stainless steel

Stem seal: O-ring EPDM

Valve seat: PTFE, O-ring EPDM

Diaphragm: EPDM

Manufacture: Belimo

Type: C215QP(T)-B (DN 15, 210 l/h)

Type: C215QP(T)-D (DN 15, 420 l/h)

Type: C220QP(T)-F (DN 20, 980 l/h)

(T) = Version with measuring ports

Self-balanced variable-flow 2-pipe system

Belimo actuator for (PI)QCV

Rotary actuator for zone valves.
Snap-assembly of the actuator, overload protected and without end switches, current reduction in rest position.

Torque motor: 1 Nm
Nominal voltage: AC 24 V 50/60 Hz, DC 24 V
Positioning signal: modulating DC 0...10 V
Operating range: DC 2...10 V
Power consumption:
- in operation: 0,3 W
- in rest position: 0,2 W
- for wire sizing: 0,6 VA
Connection: cable 1 m, 3 x 0.75 mm²
Actuating time: 75 s / 90°
Protection class: III Safety extra-low voltage
Degree of protection: IP40
EMC: CE according to 2004/108/EC

Manufacture: Belimo
Type: CQ24A-SR

Further types available: AC/DC 24 V, AC 230 V, open-close, 3-point, MP-Bus light, with emergency position, ...

Including electrical/mechanical connections and accessories.

5 years of product warranty

Short tender specification

Belimo PIQCV: pressure-independent 2-way zero-leaking valve with adjustable flow rate setting, DN 15 or DN 20, with actuator

Belimo – features and benefits

Feature	Benefit
Pressure-independent	Quick and safe valve selection according to flow rate, no calculation of k_v
	Ideal room comfort due to correct flow rate at any time
Automatic and permanent hydraulic balancing	Fast commissioning, no balancing valves needed
Compact size	Maximum efficiency in space and high design freedom
Zero-leaking valve	Circulation and energy losses are eliminated
Self-cleaning ball valve	Outstanding resistance to contamination, smooth operation even after prolonged closures
Equal percentage flow characteristic without inlet jump	Perfect controllability, even in part load situations
Variable V'_{max} setting	Highest flexibility during planning, installation and use phase
Low power consumption actuator	Energy costs reduced by up to 90% compared to conventional zone valves

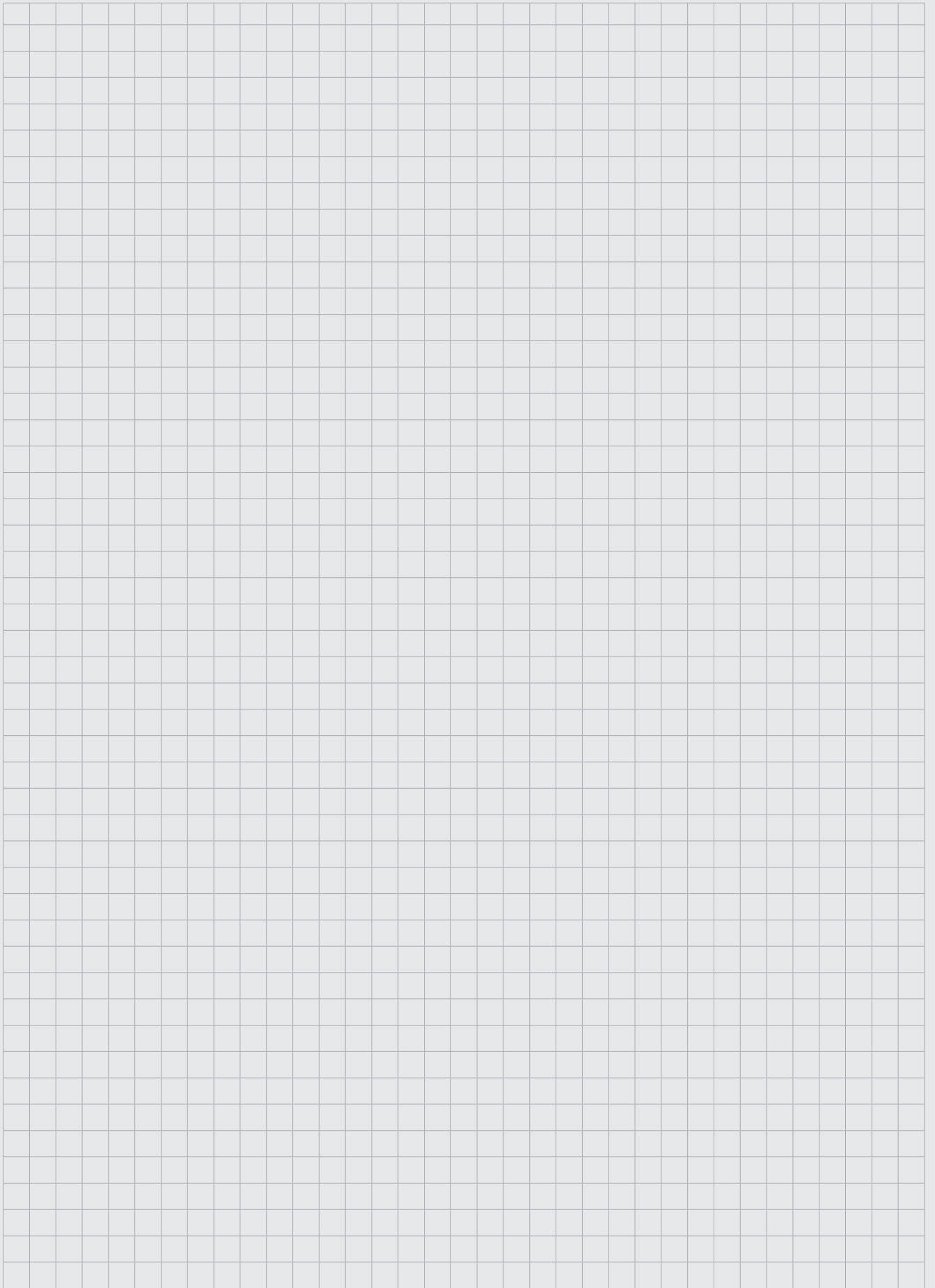

2.4 Several fan coils

Self-balanced variable-flow 2-pipe system

2

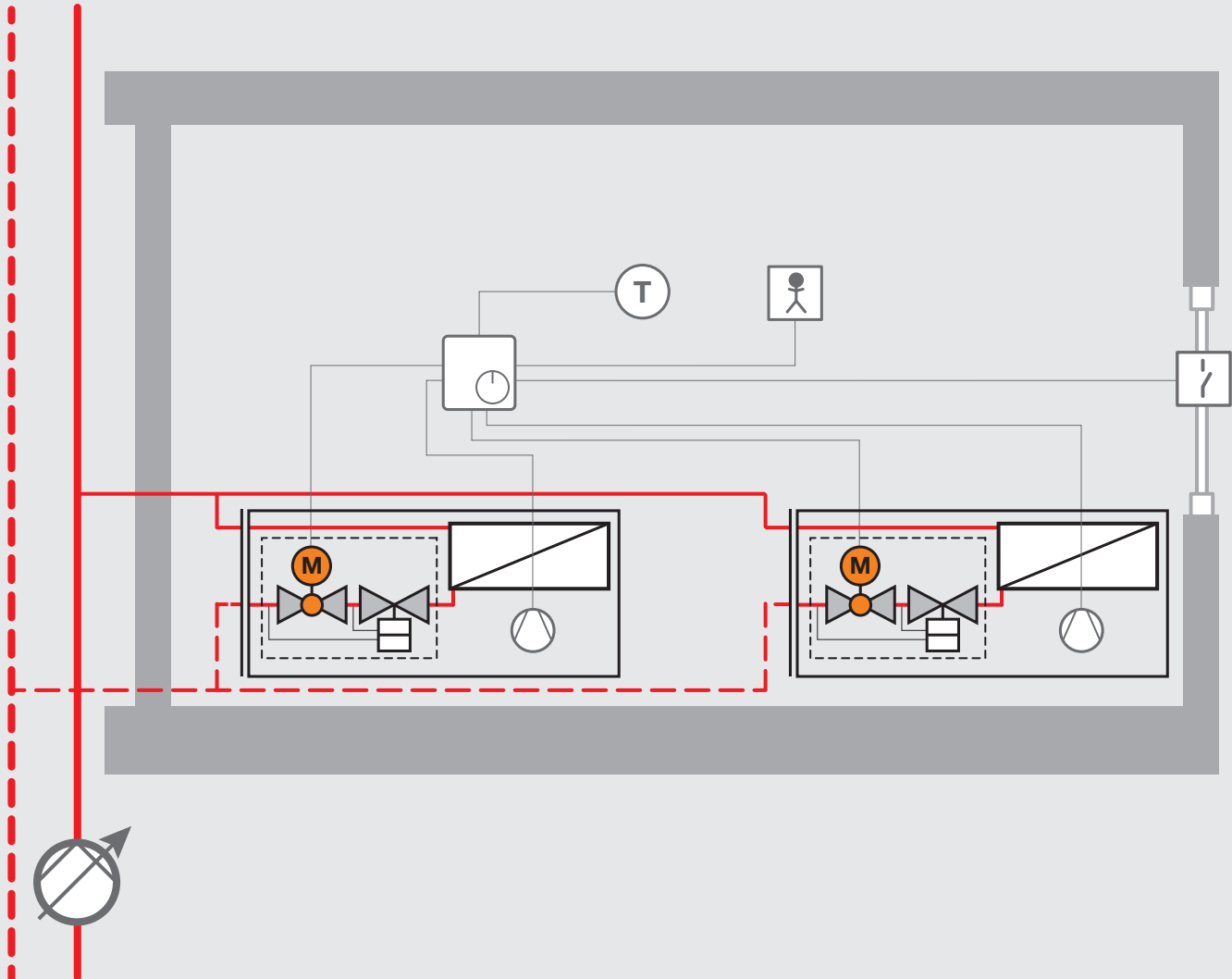

Example illustration

Circuit functions

- Thermal power supplied by means of fan coils
- Permanent hydraulic balancing (in any load condition) of the water flow achieved by the pressure-independent control valve
- Pump with variable speed depending on the differential pressure in the system's most disadvantaged circuit
- Flow rates and fan speeds adjusted by one room temperature controller
- Type of control of the actuator: Open-close, 3-point, modulating or Bus
- Optional functions: presence monitoring, window monitoring

Controller

Room temperature controller with:

- fan speed variation (3 speeds with 3 DO or modulating with 1 AO)
 - water flow variation with ON/OFF control, 3-points, modulating 0...10 V, Bus
- Optional: Integration of signal from a presence detector and/or window contact switch

Bill of material

Typ	Description	Quantity	Costs
C2..QP(T)-..	Belimo pressure-independent 2-way zone valve PIQCV, DN .. with adjustable V_{max} ...-... l/h	(*)	
CQ2..	Belimo rotary actuator for zone valves, ... V, control:	(*)	
EXT-OC-ZQ..-P(T)	Optional: Insulation for C2..QP(T) valve, 2-way, DN ..	(*)	
ZR23..	Optional: Pipe connector for zone valve DN ..	(*) x 2	
	Room temperature controller	1	
	Temperature sensor	1	
	Optional sensor: presence detector, window contact switch, ...		

(*) Possibility of controlling several fan coils with one room temperature controller. The maximum number of controllable terminal devices is dependent on the room temperature controller.

Extended tender specification

Belimo PIQCV (Pressure-Independent-Quick-Compact-Valve)

Supply and installation of pressure-independent 2-way valve with automatic permanent hydraulic balancing, equal percentage characteristic curve, no leakage and high dirt-resistance.

Pressure independent zone valve (characterised control valve), 2-way with internal thread.

For water-side modulating control in heating and air handling systems.

Snap-assembly of the actuator, pressure-reducing valve for constant flow rate independently from pressure variations.

With measuring ports for verification of pressure value (optional version).

Construction type: straight way valve 2-way, DN 15 or DN 20

Connection: internal thread Rp 1/2" (DN 15) or Rp 3/4" (DN 20)

Flow rate V_{max} : max. 210 l/h, adjustable [C215QP(T)-B]

Flow rate V_{max} : max. 420 l/h, adjustable [C215QP(T)-D]

Flow rate V_{max} : max. 980 l/h, adjustable [C220QP(T)-F]

Media: Cold and warm water, water with glycol up to max. 50% vol.

Leakage rate A, tight (EN12266-1)

Flow characteristic: equal percentage (VDI/VDE 2178), optimised in the opening range

Media temperature: +2...+90 °C

Permissible pressure ps: 1600 kPa

Closing pressure dps: 700 kPa

Pressure value: 16...350 kPa

Housing: brass body

Closing element: stainless steel

Stem: stainless steel

Stem seal: O-ring EPDM

Valve seat: PTFE, O-ring EPDM

Diaphragm: EPDM

Manufacture: Belimo

Type: C215QP(T)-B (DN 15, 210 l/h)

Type: C215QP(T)-D (DN 15, 420 l/h)

Type: C220QP(T)-F (DN 20, 980 l/h)

(T) = Version with measuring ports

Self-balanced variable-flow 2-pipe system

Belimo actuator for (PI)QCV

Rotary actuator for zone valves.
Snap-assembly of the actuator, overload protected and without end switches, current reduction in rest position.

Torque motor: 1 Nm
Nominal voltage: AC 24 V 50/60 Hz, DC 24 V
Positioning signal: modulating DC 0...10 V
Operating range: DC 2...10 V
Power consumption:
- in operation: 0,3 W
- in rest position: 0,2 W
- for wire sizing: 0,6 VA
Connection: cable 1 m, 3 x 0.75 mm²
Actuating time: 75 s / 90°
Protection class: III Safety extra-low voltage
Degree of protection: IP40
EMC: CE according to 2004/108/EC

Manufacture: Belimo
Type: CQ24A-SR

Further types available: AC/DC 24 V, AC 230 V, open-close, 3-point, MP-Bus light, with emergency position, ...

Including electrical/mechanical connections and accessories.

5 years of product warranty

Short tender specification

Belimo PIQCV: pressure-independent 2-way zero-leaking valve with adjustable flow rate setting, DN 15 or DN 20, with actuator

Belimo – features and benefits

Feature	Benefit
Pressure-independent	Quick and safe valve selection according to flow rate, no calculation of k_v
	Ideal room comfort due to correct flow rate at any time
Automatic and permanent hydraulic balancing	Fast commissioning, no balancing valves needed
Compact size	Maximum efficiency in space and high design freedom
Zero-leaking valve	Circulation and energy losses are eliminated
Self-cleaning ball valve	Outstanding resistance to contamination, smooth operation even after prolonged closures
Equal percentage flow characteristic without inlet jump	Perfect controllability, even in part load situations
Variable V'_{max} setting	Highest flexibility during planning, installation and use phase
Low power consumption actuator	Energy costs reduced by up to 90% compared to conventional zone valves

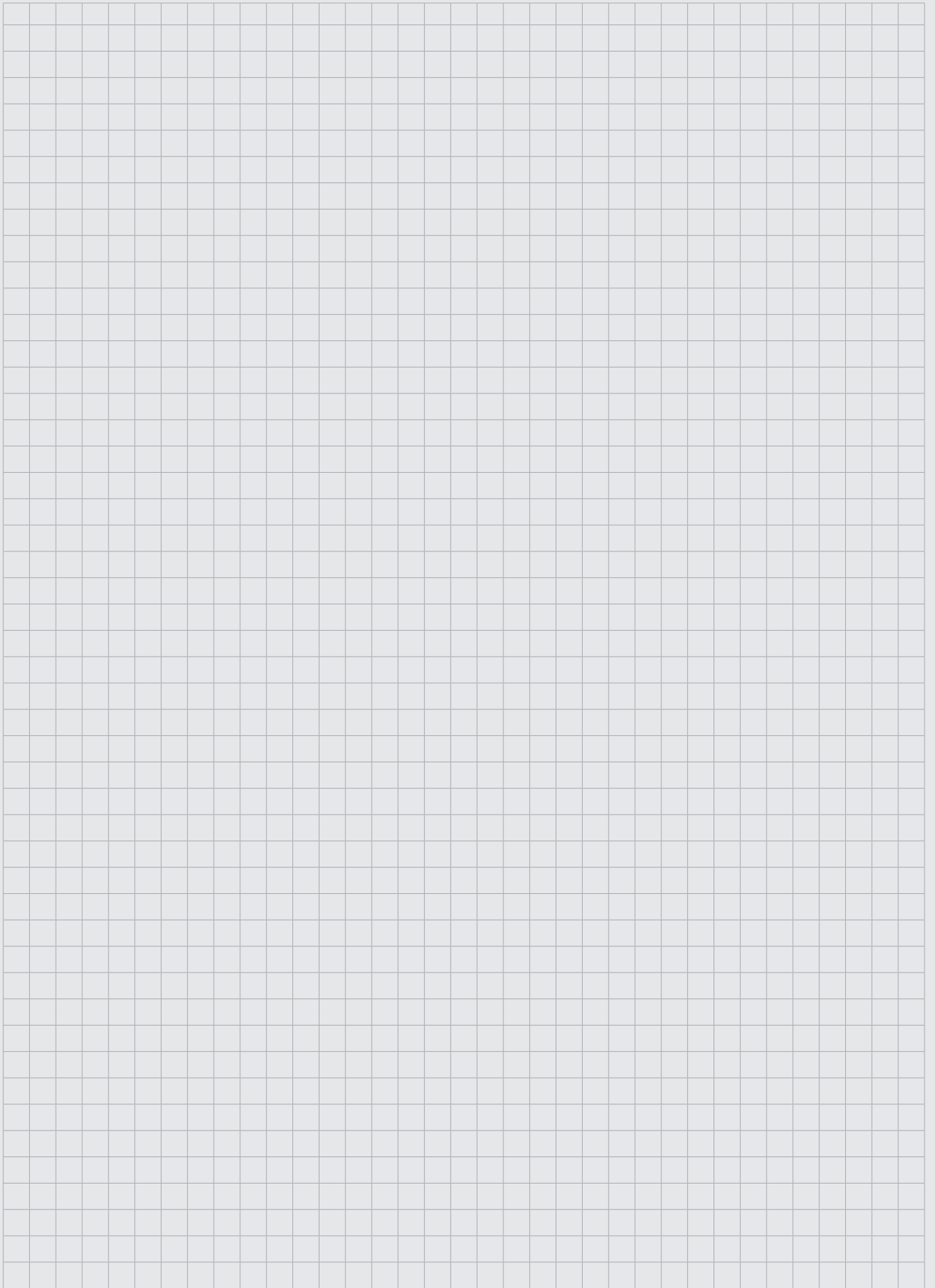

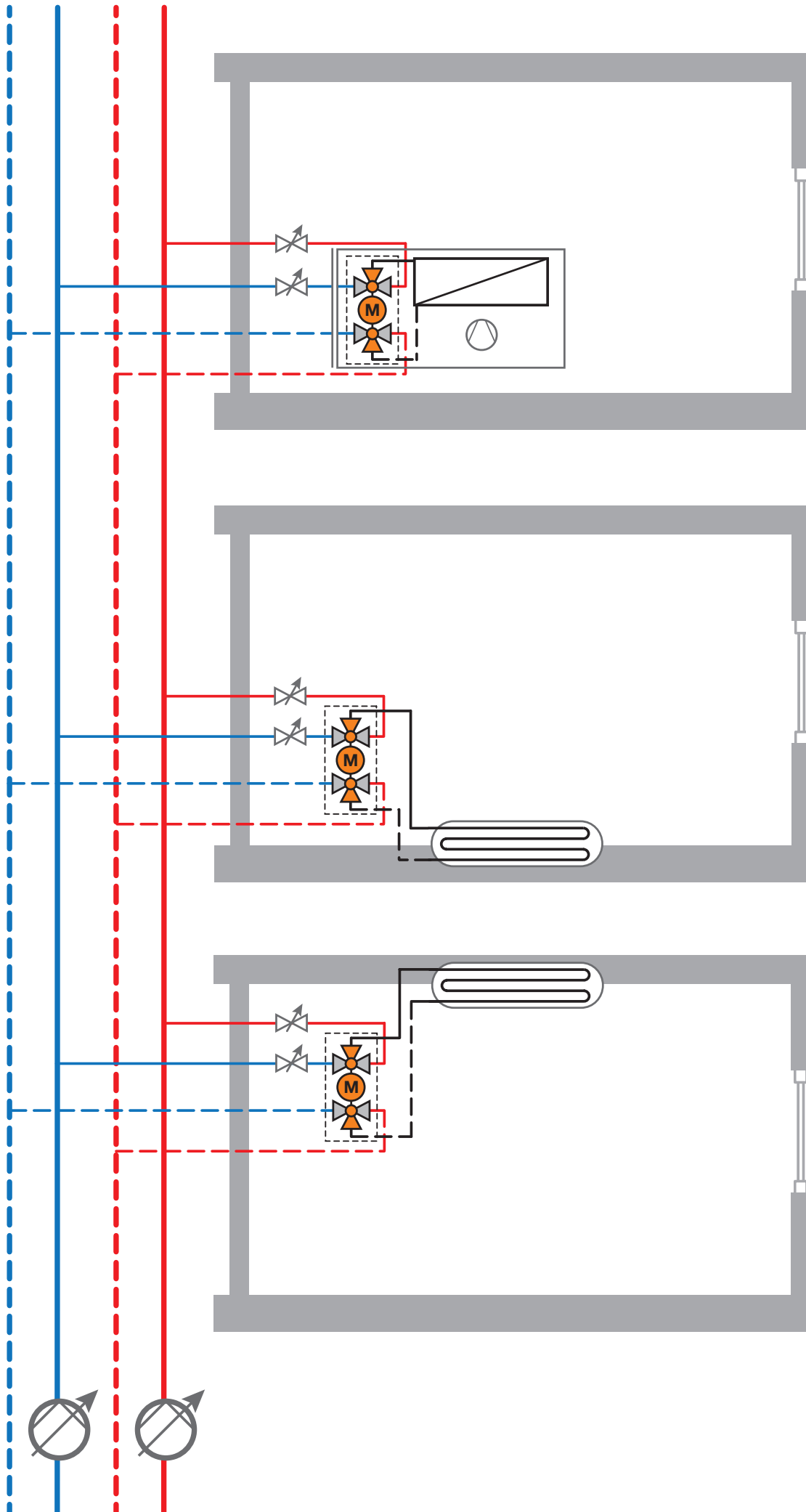

3

Variable-flow 4-pipe system

	3.1	Fan coil	44
Variable-flow 4-pipe system	3.2	Floor heating (with cooling)	48
	3.3	Heating- and cooling ceiling	52

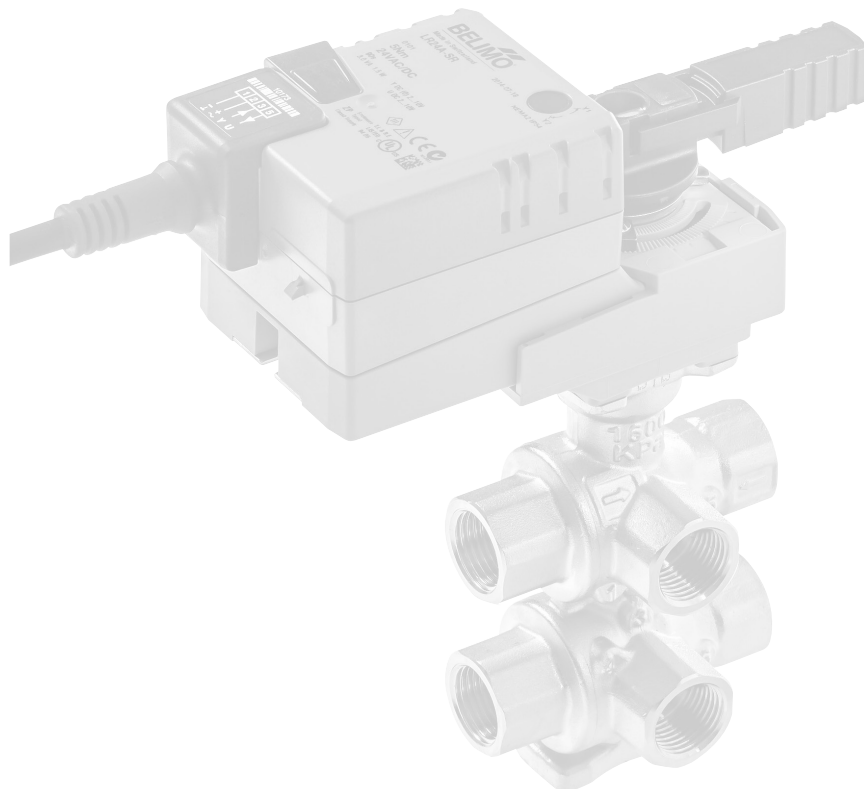

3.1 Fan coil

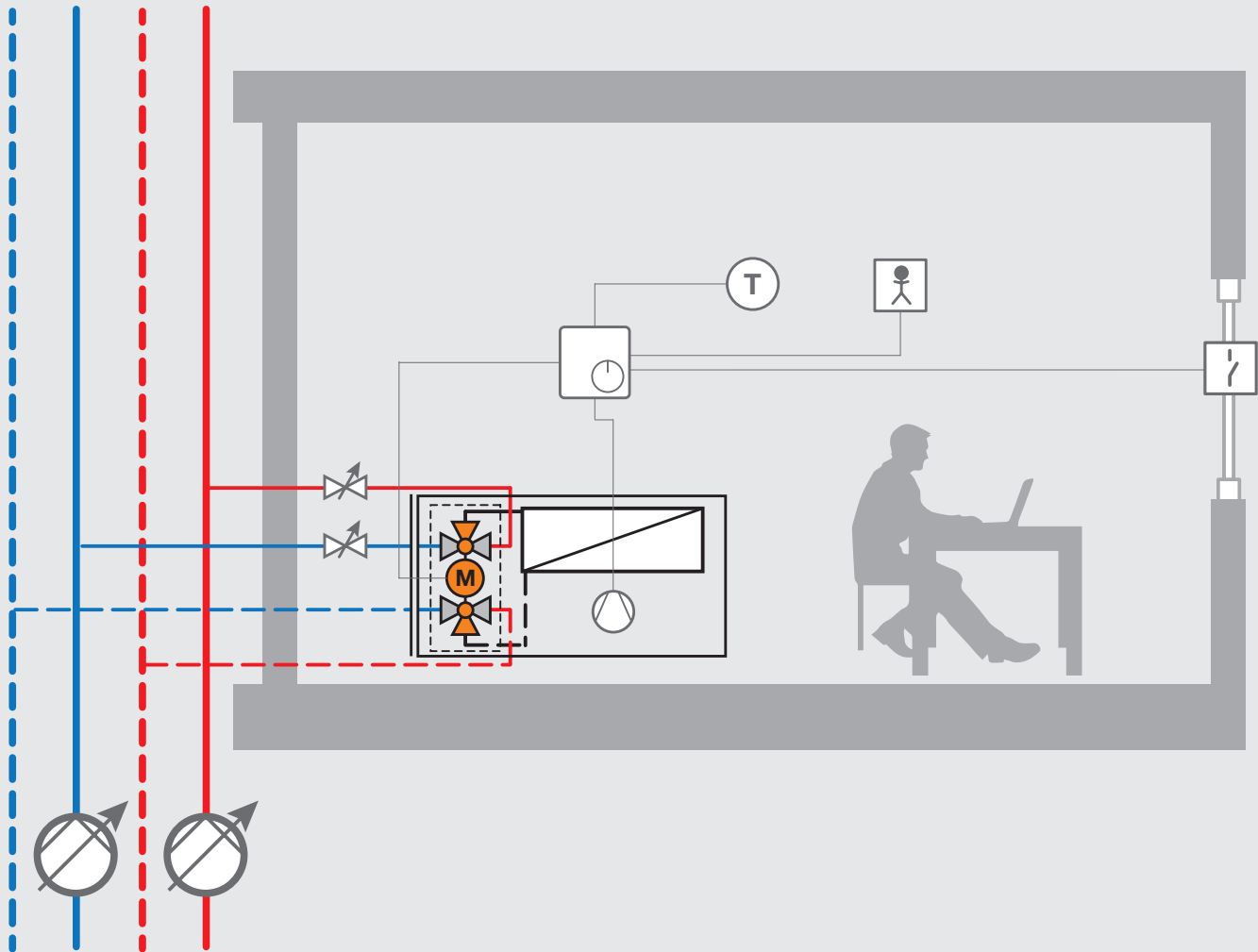

Example illustration

Circuit functions

- Thermal power (heating and cooling) supplied by means of fan coil with one heat exchanger
- 4-pipe system ensures the immediate availability of hot and chilled water
- 4-pipe system allows the cooling of some rooms while heating others
- Static hydraulic balancing (for full load) of the water flow achieved by manual balancing valves
- Pump with variable speed depending on the differential pressure in the system's most disadvantaged circuit
- Flow rate and fan speed adjusted by the room temperature controller
- Type of control of the of the actuator: modulating or Bus
- Optional functions: presence monitoring, window monitoring

Controller

Room temperature controller with:

- fan speed variation (3 speeds with 3 DO or modulating with 1 AO)
- water flow variation with control 0...10 V or via Bus

Optional: Integration of signal from a presence detector and/or window contact switch

Bill of material

Typ	Description	Quantity	Costs
R30...-...-B2	Belimo 6-way zone valve, DN .., k_{vs1} ... m^3/h , k_{vs2} ... m^3/h	1	
LR24A..	Belimo rotary actuator 5 Nm, ... V, control:	1	
EXT-OC-ZR30..	Optional: Insulation for 6-way valve, DN ..	1	
ZR23..	Optional: Pipe connector for zone valve DN ..	6	
ZR-004	Optional: Fastening angle for 6-way valve DN 15 + DN 20	1	
	Balancing valve DN ..	2	
	Work time required: Hydraulic balancing	1 h	
	Room temperature controller	1	
	Temperature sensor	1	
	Optional sensor: presence detector, window contact switch, ...		

Extended tender specification

Belimo 6-way zone valve

Supply and installation of 6-way valve with two control sequences (heating/cooling), no leakage and high dirt-resistance.

Zone valve (characterised control valve), 6-way with internal thread.

For water-side switching or modulating control of thermal heating/cooling elements, with integrated pressure relief function.

Construction type: 6-way valve, DN 15 or DN 20

Connection: internal thread Rp 1/2" (DN 15) or Rp 3/4" (DN 20)

k_{vs} value:

- Cooling: ... m^3/h

- Heating: ... m^3/h

Media: Cold and warm water, water with glycol up to max. 50% vol.

Leakage rate A, air-bubble-tight (EN12266-1)

Flow characteristic: linear

- Sequence 1: 0...30° (Cooling recommended)

- Dead zone: 30...60°

- Sequence 2: 60...90° (Heating recommended)

Media temperature: +6...+80 °C

Permissible pressure ps: 1600 kPa

Differential pressure dp_{max} : 100 kPa

Housing: brass body nickel-plated

Closing element: chrome-plated brass

Stem: nickel-plated brass

Stem seal: O-ring EPDM

Valve seat: PTFE, O-ring EPDM

Flow rate diaphragms: stainless steel

Manufacture: Belimo

Type: R3015-...-B2 (DN 15)

Type: R3020-...-B2 (DN 20)

Variable-flow 4-pipe system

Belimo rotary actuator for 6-way zone valve

Rotary actuator for 6-way zone valves and 2- and 3-way characterised control valves. Straightforward direct mounting on the ball valve with only one central screw. The assembly tool is integrated in the plug-in position indication. Overload protected and without end switches, current reduction in rest position.

Torque motor: 5 Nm
 Nominal voltage: AC 24 V 50/60 Hz, DC 24 V
 Positioning signal: modulating DC 0...10 V
 Operating range: DC 2...10 V
 Position feedback: DC 2...10 V
 Power consumption:
 - in operation: 1.5 W
 - in rest position: 0,4 W
 - for wire sizing: 3 VA
 Connection: cable 1 m, 4 x 0.75 mm²
 Actuating time: 90 s / 90°
 Protection class: III Safety extra-low voltage
 Degree of protection: IP54
 EMC: CE according to 2004/108/EC

Manufacture: Belimo
 Type: LR24A-SR

Many other types available to cover the different needs (e.g. Bus)

Including electrical/mechanical connections and accessories.

5 years of product warranty

Short tender specification

Belimo 6-way zone valve, zero-leaking valve, DN ..., with actuator

Belimo – features and benefits

Feature	Benefit
Air-bubble tight valve	Circulation and energy losses are eliminated
Self-cleaning ball valve	Outstanding resistance to contamination, smooth operation even after prolonged closures
Replaces four 2 port valves	Reduced expense for planning, installation and operation Eliminates installation errors Requires only one control sequence
Integrated pressure relief function	Maximum plant safety
Different k_{VS} -values for Sequence 1 and 2	Enables optimum design of the cooling and heating circuit

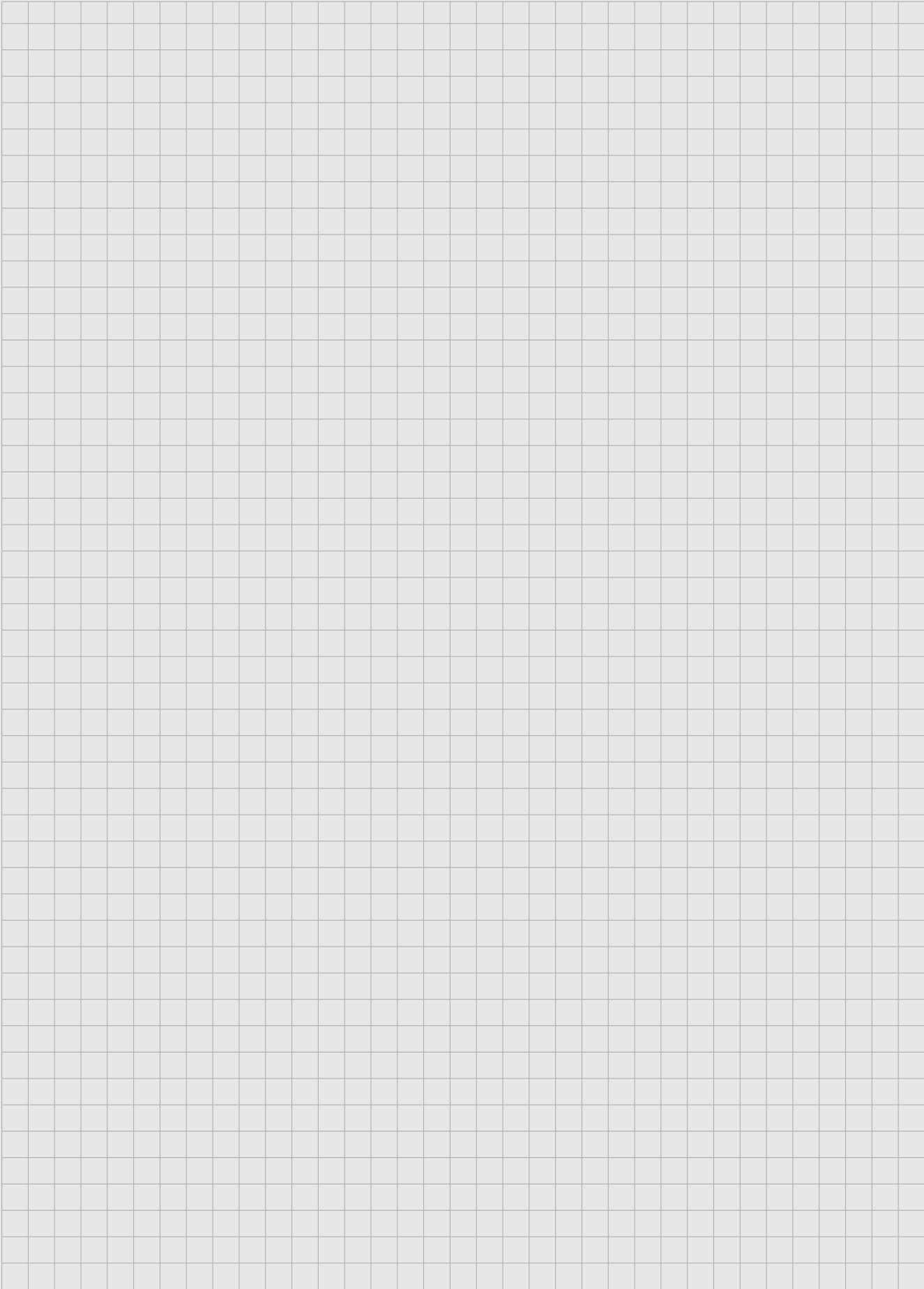

3.2 Floor heating (with cooling)

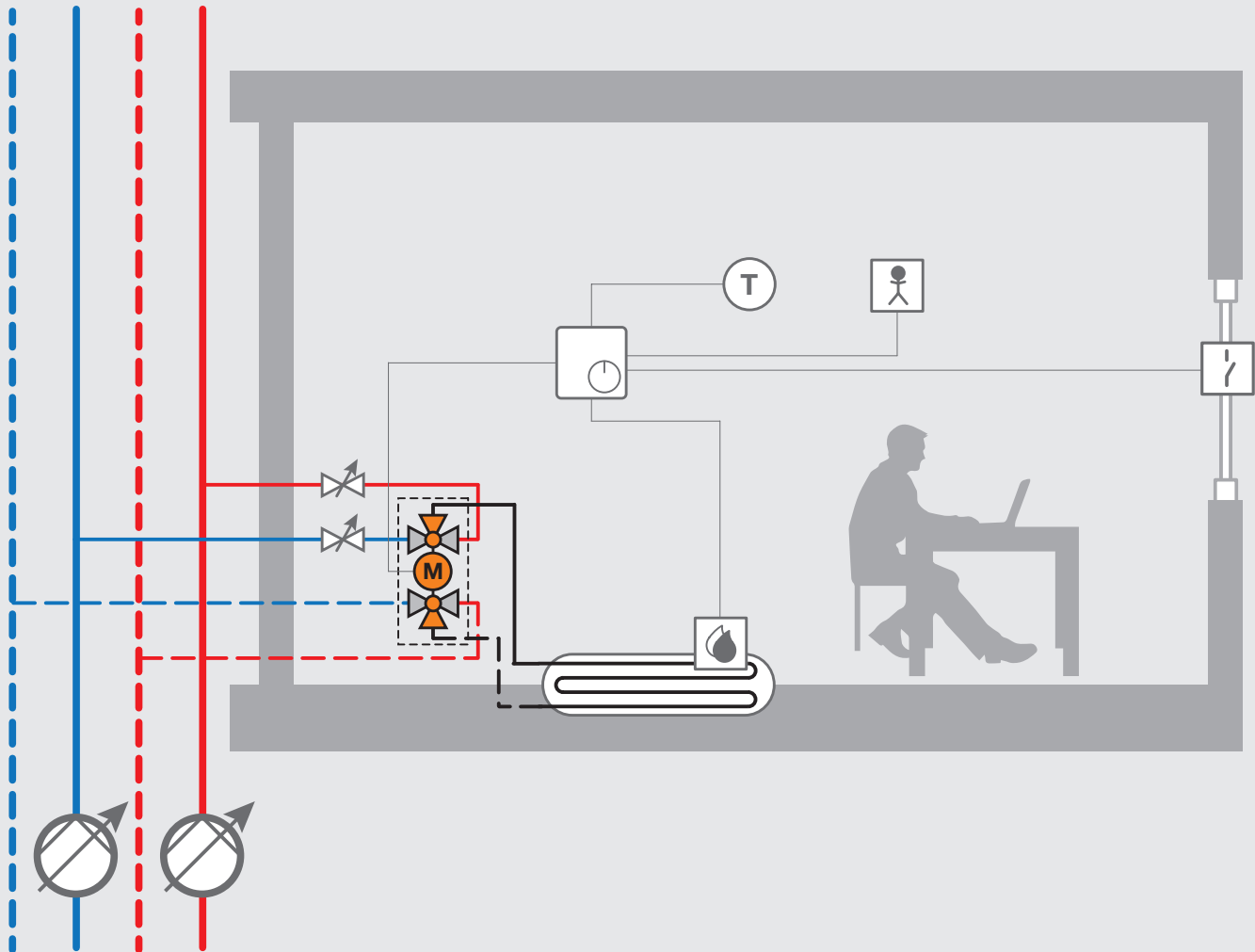

Example illustration

Circuit functions

- Thermal power supplied by means of floor-mounted or wall-mounted heating elements
- 4-pipe system ensures the immediate availability of hot and chilled water
- 4-pipe system allows the cooling of some rooms while heating others
- Static hydraulic balancing (for full load) of the water flow achieved by manual balancing valves
- Pump with variable speed depending on the differential pressure in the system's most disadvantaged circuit
- Flow rate adjusted by the room temperature controller
- Automatic shut-off if the temperature falls below the dew point
- Automatic shut-off in the event of an open window
- Type of control of the actuator: modulating or Bus
- Optional functions: presence monitoring

Controller

Room temperature controller with:

- water flow variation with modulating 0...10 V or Bus
- valve shut-off upon signal from dew-point sensor
- valve shut-off upon window contact signal

Optional: Integration of signal from a presence detector

Bill of material

Typ	Description	Quantity	Costs
R30...-...-B2	Belimo 6-way zone valve, DN .., k_{VS1} ... m^3/h , k_{VS2} ... m^3/h	1	
LR24A..	Belimo rotary actuator 5 Nm, ... V, control:	1	
EXT-OC-ZR30..	Optional: Insulation for 6-way valve, DN ..	1	
ZR23..	Optional: Pipe connector for zone valve DN ..	6	
ZR-004	Optional: Fastening angle for 6-way valve DN 15 + DN 20	1	
	Balancing valve DN ..	2	
	Work time required: Hydraulic balancing	1 h	
	Room temperature controller	1	
	Temperature sensor	1	
	Dew-point sensor	1	
	Optional sensor: presence detector, window contact switch, ...		

Extended tender specification

Belimo 6-way zone valve

Supply and installation of 6-way valve with two control sequences (heating/cooling), no leakage and high dirt-resistance.

Zone valve (characterised control valve), 6-way with internal thread.

For water-side switching or modulating control of thermal heating/cooling elements, with integrated pressure relief function.

Construction type: 6-way valve, DN 15 or DN 20

Connection: internal thread Rp 1/2" (DN 15) or Rp 3/4" (DN 20)

k_{VS} value:

- Cooling: ... m^3/h

- Heating: ... m^3/h

Media: Cold and warm water, water with glycol up to max. 50% vol.

Leakage rate A, air-bubble-tight (EN12266-1)

Flow characteristic: linear

- Sequence 1: 0...30° (Cooling recommended)

- Dead zone: 30...60°

- Sequence 2: 60...90° (Heating recommended)

Media temperature: +6...+80 °C

Permissible pressure ps: 1600 kPa

Differential pressure dpmax: 100 kPa

Housing: brass body nickel-plated

Closing element: chrome-plated brass

Stem: nickel-plated brass

Stem seal: O-ring EPDM

Valve seat: PTFE, O-ring EPDM

Flow rate diaphragms: stainless steel

Manufacture: Belimo

Type: R3015-...-B2 (DN 15)

Type: R3020-...-B2 (DN 20)

Variable-flow 4-pipe system

Belimo rotary actuator for 6-way zone valve

Rotary actuator for 6-way zone valves and 2- and 3-way characterised control valves. Straightforward direct mounting on the ball valve with only one central screw. The assembly tool is integrated in the plug-in position indication. Overload protected and without end switches, current reduction in rest position.

Torque motor: 5 Nm
 Nominal voltage: AC 24 V 50/60 Hz, DC 24 V
 Positioning signal: modulating DC 0...10 V
 Operating range: DC 2...10 V
 Position feedback: DC 2...10 V
 Power consumption:
 - in operation: 1.5 W
 - in rest position: 0,4 W
 - for wire sizing: 3 VA
 Connection: cable 1 m, 4 x 0.75 mm²
 Actuating time: 90 s / 90°
 Protection class: III Safety extra-low voltage
 Degree of protection: IP54
 EMC: CE according to 2004/108/EC

Manufacture: Belimo
 Type: LR24A-SR

Many other types available to cover the different needs (e.g. Bus)

Including electrical/mechanical connections and accessories.

5 years of product warranty

Short tender specification

Belimo 6-way zone valve, zero-leaking valve, DN ..., with actuator

Belimo – features and benefits

Feature	Benefit
Air-bubble tight valve	Circulation and energy losses are eliminated
Self-cleaning ball valve	Outstanding resistance to contamination, smooth operation even after prolonged closures
Replaces four 2 port valves	Reduced expense for planning, installation and operation Eliminates installation errors Requires only one control sequence
Integrated pressure relief function	Maximum plant safety
Different k_{VS} -values for Sequence 1 and 2	Enables optimum design of the cooling and heating circuit

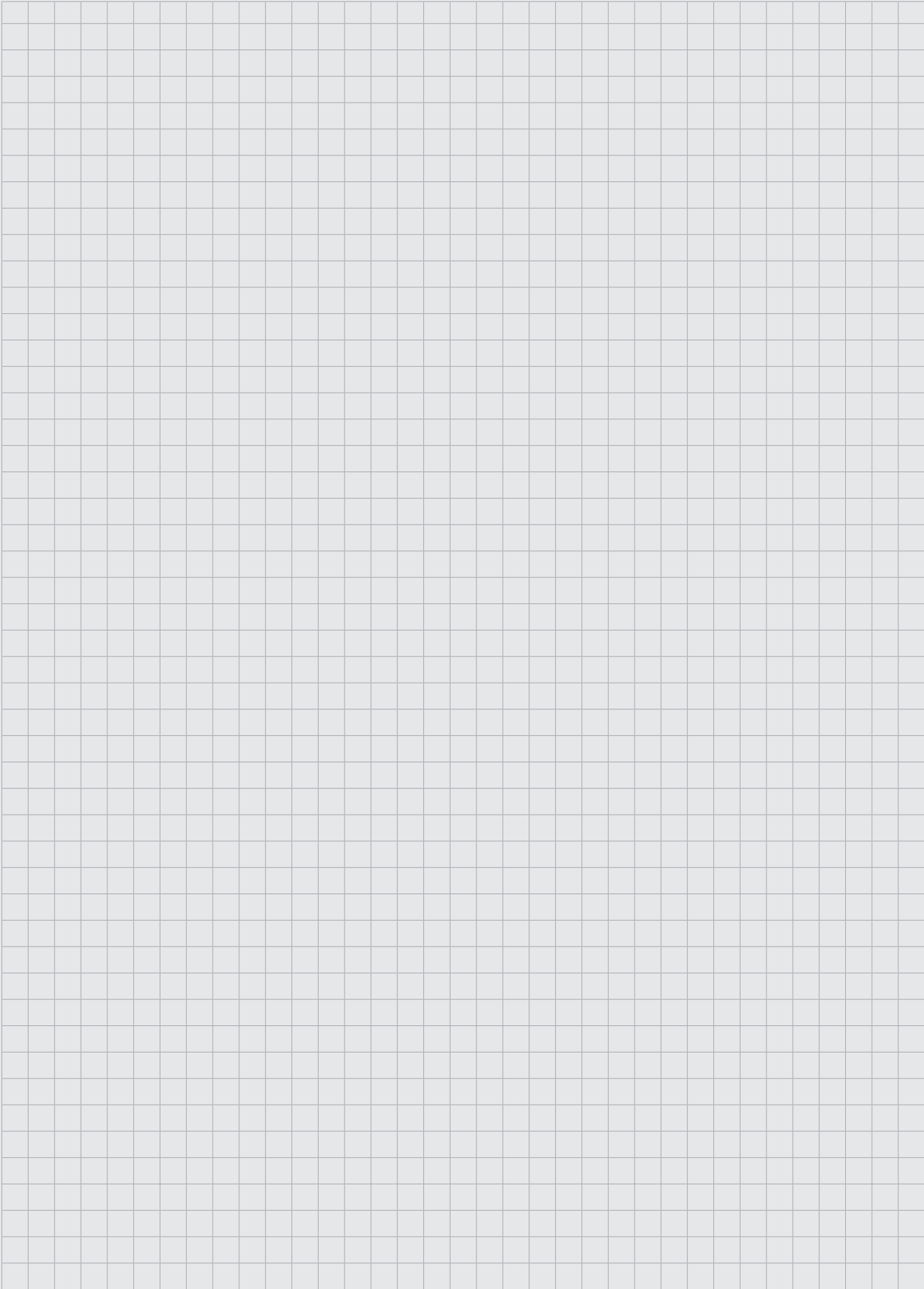

3.3 Heating- and cooling ceiling

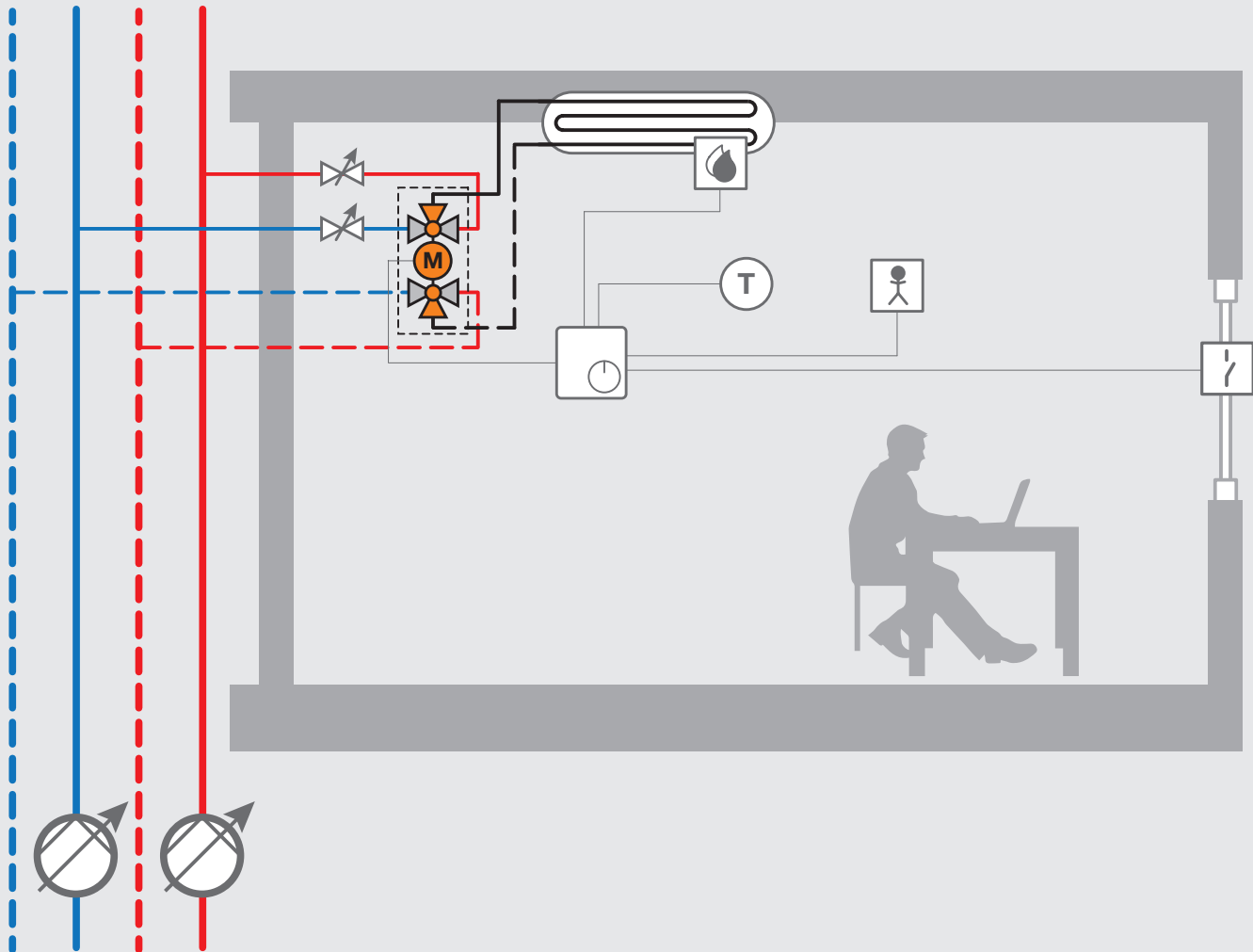

Example illustration

Circuit functions

- Thermal power supplied by chilled/heated ceiling
- 4-pipe system ensures the immediate availability of hot and chilled water
- 4-pipe system allows the cooling of some rooms while heating others
- Static hydraulic balancing (for full load) of the water flow achieved by manual balancing valves
- Pump with variable speed depending on the differential pressure in the system's most disadvantaged circuit
- Flow rate adjusted by the room temperature controller
- Automatic shut-off if the temperature falls below the dew point
- Automatic shut-off in the event of an open window
- Type of control of the actuator: modulating or Bus
- Optional functions: presence monitoring

Controller

Room temperature controller with:

- water flow variation modulating 0...10 V or Bus
- valve shut-off upon signal from dew-point sensor
- valve shut-off upon window contact signal

Optional: Integration of signal from a presence detector

Bill of material

Typ	Description	Quantity	Costs
R30...-...-B2	Belimo 6-way zone valve, DN .., k_{VS1} ... m^3/h , k_{VS2} ... m^3/h	1	
LR24A..	Belimo rotary actuator 5 Nm, ... V, control:	1	
EXT-OC-ZR30..	Optional: Insulation for 6-way valve, DN ..	1	
ZR23..	Optional: Pipe connector for zone valve DN ..	6	
ZR-004	Optional: Fastening angle for 6-way valve DN 15 + DN 20	1	
	Balancing valve DN ..	2	
	Work time required: Hydraulic balancing	1 h	
	Room temperature controller	1	
	Temperature sensor	1	
	Dew-point sensor	1	
	Window contact switch	1	
	Optional sensor: presence detector		

Extended tender specification

Belimo 6-way zone valve

Supply and installation of 6-way valve with two control sequences (heating/cooling), no leakage and high dirt-resistance.

Zone valve (characterised control valve), 6-way with internal thread.

For water-side switching or modulating control of thermal heating/cooling elements, with integrated pressure relief function.

Construction type: 6-way valve, DN 15 or DN 20

Connection: internal thread Rp 1/2" (DN 15) or Rp 3/4" (DN 20)

k_{VS} value:

- Cooling: ... m^3/h

- Heating: ... m^3/h

Media: Cold and warm water, water with glycol up to max. 50% vol.

Leakage rate A, air-bubble-tight (EN12266-1)

Flow characteristic: linear

- Sequence 1: 0...30° (Cooling recommended)

- Dead zone: 30...60°

- Sequence 2: 60...90° (Heating recommended)

Media temperature: +6...+80 °C

Permissible pressure ps: 1600 kPa

Differential pressure dp_{max} : 100 kPa

Housing: brass body nickel-plated

Closing element: chrome-plated brass

Stem: nickel-plated brass

Stem seal: O-ring EPDM

Valve seat: PTFE, O-ring EPDM

Flow rate diaphragms: stainless steel

Manufacture: Belimo

Type: R3015-...-B2 (DN 15)

Type: R3020-...-B2 (DN 20)

Variable-flow 4-pipe system

Belimo rotary actuator for 6-way zone valve

Rotary actuator for 6-way zone valves and 2- and 3-way characterised control valves. Straightforward direct mounting on the ball valve with only one central screw. The assembly tool is integrated in the plug-in position indication. Overload protected and without end switches, current reduction in rest position.

Torque motor: 5 Nm
 Nominal voltage: AC 24 V 50/60 Hz, DC 24 V
 Positioning signal: modulating DC 0...10 V
 Operating range: DC 2...10 V
 Position feedback: DC 2...10 V
 Power consumption:
 - in operation: 1.5 W
 - in rest position: 0,4 W
 - for wire sizing: 3 VA
 Connection: cable 1 m, 4 x 0.75 mm²
 Actuating time: 90 s / 90°
 Protection class: III Safety extra-low voltage
 Degree of protection: IP54
 EMC: CE according to 2004/108/EC

Manufacture: Belimo
 Type: LR24A-SR

Many other types available to cover the different needs (e.g. Bus)

Including electrical/mechanical connections and accessories.

5 years of product warranty

Short tender specification

Belimo 6-way zone valve, zero-leaking valve, DN ..., with actuator

Belimo – features and benefits

Feature	Benefit
Air-bubble tight valve	Circulation and energy losses are eliminated
Self-cleaning ball valve	Outstanding resistance to contamination, smooth operation even after prolonged closures
Replaces four 2 port valves	Reduced expense for planning, installation and operation Eliminates installation errors Requires only one control sequence
Integrated pressure relief function	Maximum plant safety
Different k_{VS} -values for Sequence 1 and 2	Enables optimum design of the cooling and heating circuit

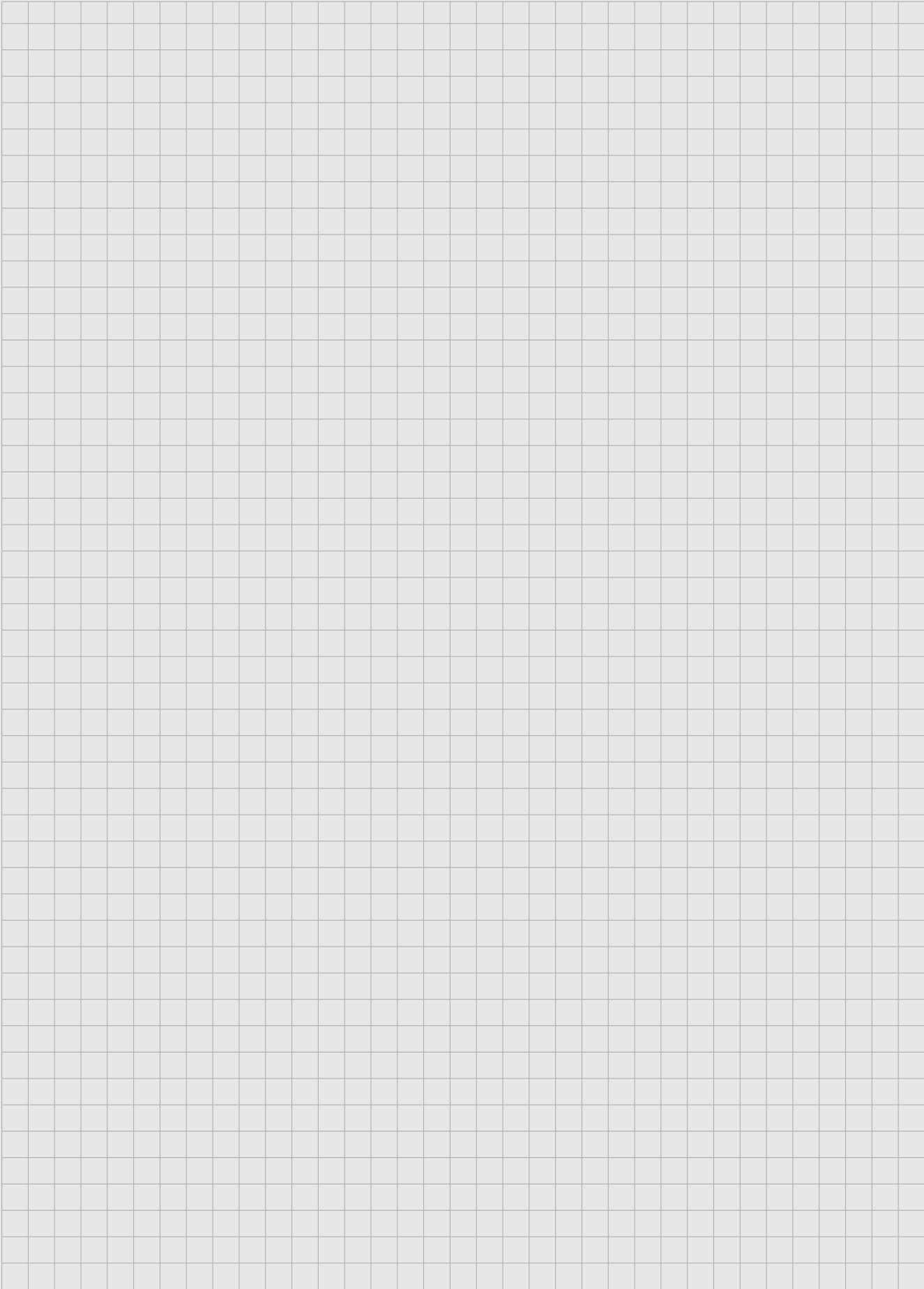

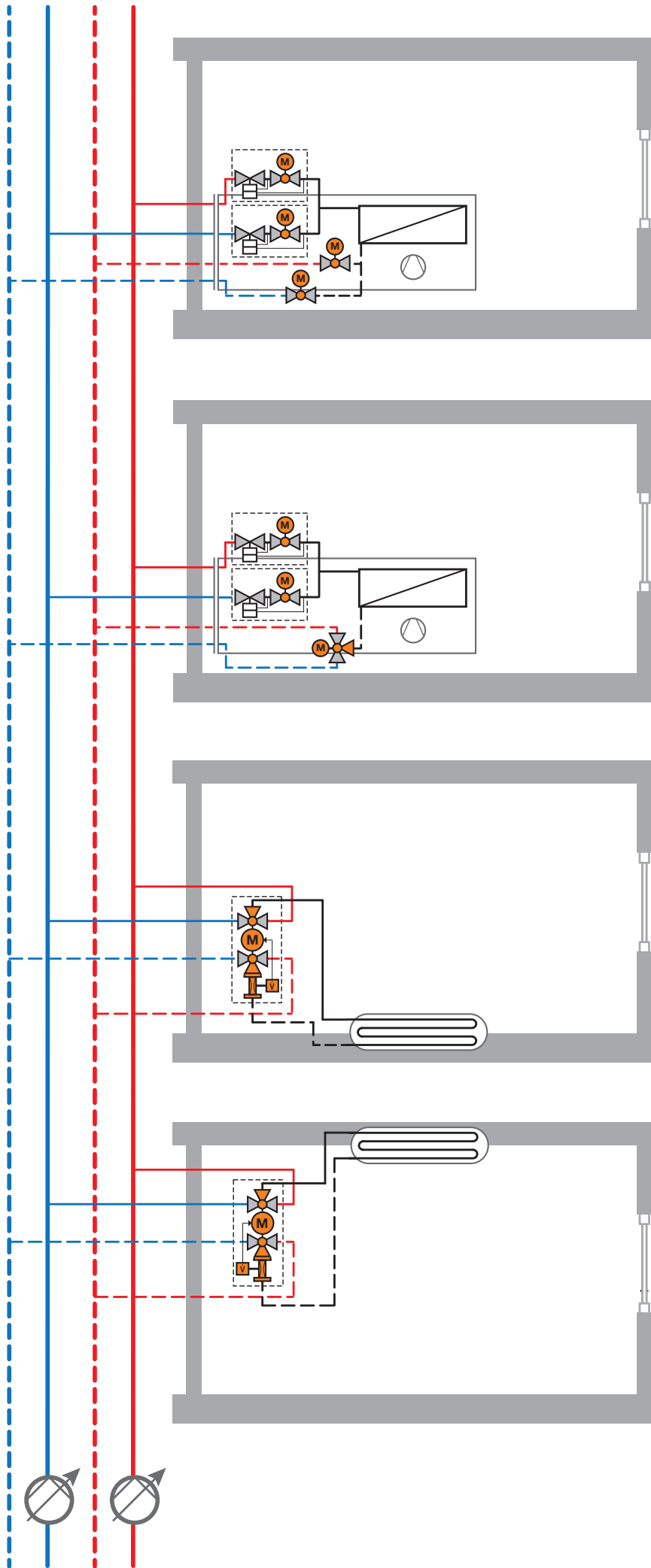

4

Self-balanced variable-flow 4-pipe system

	4.1	Fan coil	58
Self-balanced variable-flow 4-pipe system	4.1.1	Fan coil	62
	4.2	Floor heating (with cooling)	66
	4.3	Heating- and cooling ceiling	70

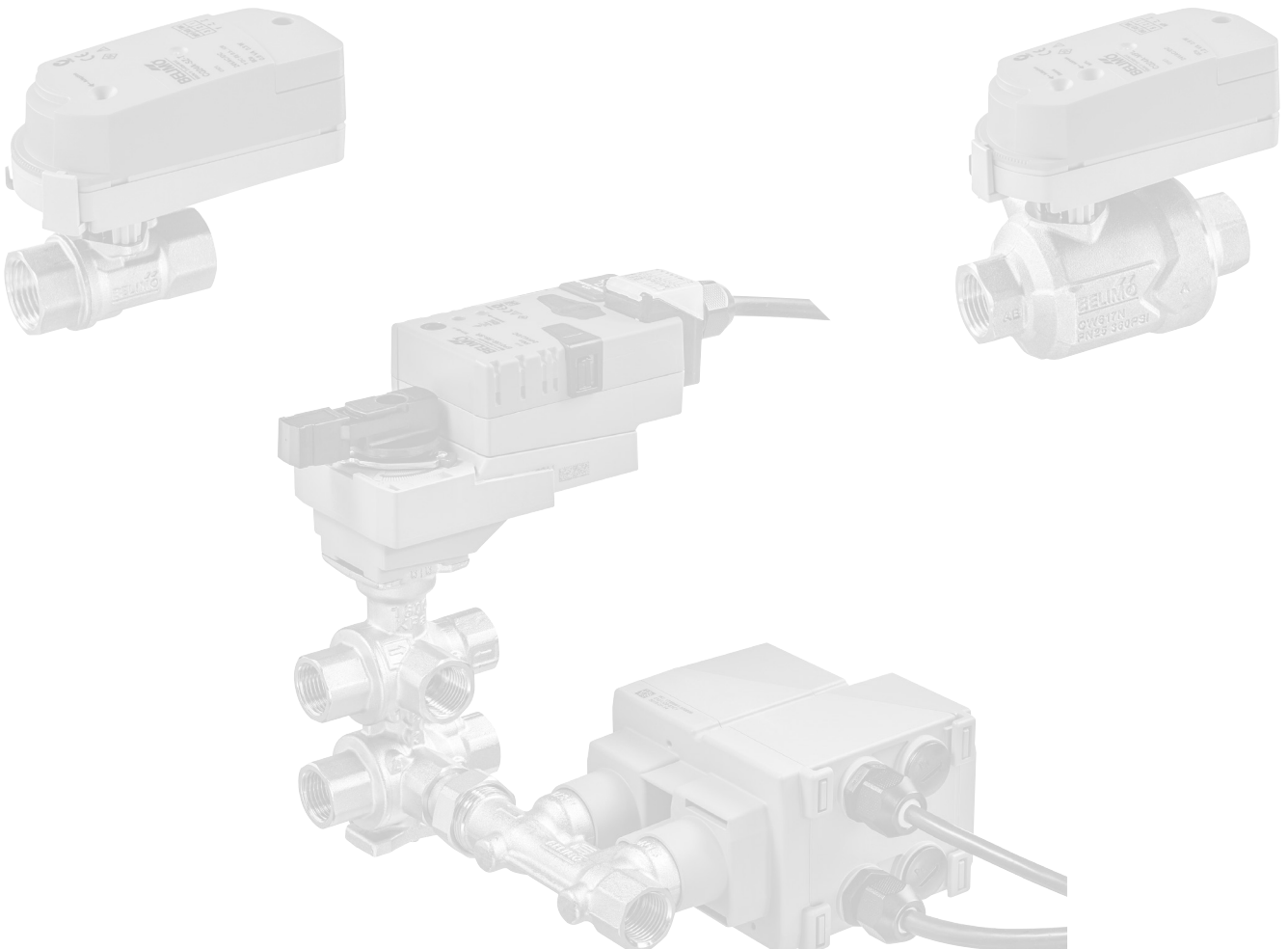

4.1 Fan coil

Self-balanced variable-flow 4-pipe system

4

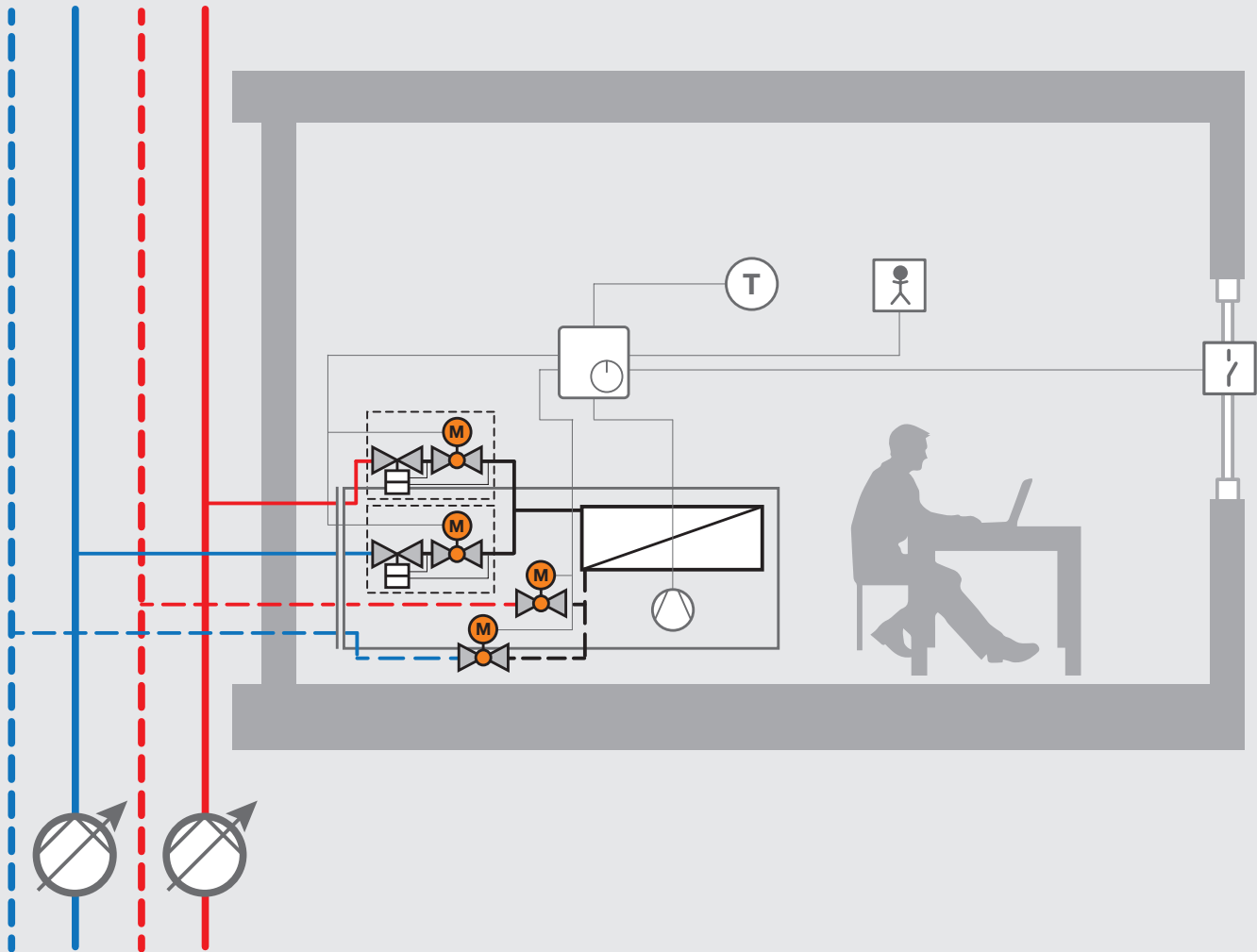

Example illustration

Circuit functions

- Thermal power (heating and cooling) supplied by means of fan coil with one heat exchanger
- 4-pipe system ensures the immediate availability of hot and chilled water
- 4-pipe system allows the cooling of some rooms while heating others
- Permanent hydraulic balancing (in any load condition) of the water flow achieved by the pressure-independent control valve
- Pump with variable speed depending on the differential pressure in the system's most disadvantaged circuit
- Flow rate and fan speed adjusted by the room temperature controller
- Type of control of the actuator (control): 3-point, modulating or Bus
- Type of control of the actuator (change-over heating/cooling): Open-close or Bus
- Optional functions: presence monitoring, window monitoring

Controller

Room temperature controller with:

- fan speed variation (3 speeds with 3 DO or modulating with 1 AO)
 - water flow variation for hot and cold sequence with 2 controls 0...10 V or 3-point or via Bus
 - hot sequence - cold sequence division with 2 controls open-close
- Optional: Integration of signal from a presence detector and/or window contact switch

Bill of material

Typ	Description	Quantity	Costs
C2..QP(T)-..	Belimo pressure-independent 2-way zone valve PIQCV, DN .. with adjustable V'_{max} ...-... l/h	2	
CQ2..	Belimo rotary actuator for zone valves, ... V, control:	2	
EXT-OC-ZQ..-P(T)	Optional: Insulation for C2..QP(T) valve, 2-way, DN ..	2	
C2..Q..	Belimo 2-way zone valve QCV, DN .. with adjustable k_v ...-... m ³ /h	2	
CQ24A	Belimo rotary actuator for zone valves, 24 V, control: Open-close (*)	2	
EXT-OC-ZR-C2..Q	Optional: Insulation for C2..Q valve, 2-way, DN ..	2	
ZR23..	Optional: Pipe connector for zone valve DN ..	8	
	Room temperature controller, 2 analogue outputs, 2 digital outputs	1	
	Temperature sensor	1	
	Optional sensor: presence detector, window contact switch, ...		

(*) also available as 230 volt version --> CQ230A

Extended tender specification

Supply and installation of kit for fan coil consisting of:

2 x Belimo PIQCV (Pressure-Independent-Quick-Compact-Valve)

Supply and installation of pressure-independent 2-way valve with automatic permanent hydraulic balancing, equal percentage characteristic curve, no leakage and high dirt-resistance.

Pressure independent zone valve (characterised control valve), 2-way with internal thread.

For water-side modulating control in heating and air handling systems.

Snap-assembly of the actuator, pressure-reducing valve for constant flow rate independently from pressure variations.

With measuring ports for verification of pressure value (optional version).

Construction type: straight way valve 2-way, DN 15 or DN 20

Connection: internal thread Rp 1/2" (DN 15) or Rp 3/4" (DN 20)

Flow rate V_{max} : max. 210 l/h, adjustable [C215QP(T)-B]

Flow rate V_{max} : max. 420 l/h, adjustable [C215QP(T)-D]

Flow rate V_{max} : max. 980 l/h, adjustable [C220QP(T)-F]

Media: Cold and warm water, water with glycol up to max. 50% vol.

Leakage rate A, tight (EN12266-1)

Flow characteristic: equal percentage (VDI/VDE 2178), optimised in the opening range

Media temperature: +2...+90 °C

Permissible pressure ps: 1600 kPa

Closing pressure dps: 700 kPa

Pressure value: 16...350 kPa

Housing: brass body

Closing element: stainless steel

Stem: stainless steel

Stem seal: O-ring EPDM

Valve seat: PTFE, O-ring EPDM

Diaphragm: EPDM

Manufacture: Belimo

Type: C215QP(T)-B (DN 15, 210 l/h)

Type: C215QP(T)-D (DN 15, 420 l/h)

Type: C220QP(T)-F (DN 20, 980 l/h)

(T) = Version with measuring ports

Self-balanced variable-flow 4-pipe system

2 x Belimo QCV (Quick-Compact-Valve)

Supply and installation of 2-way valve with equal percentage characteristic curve, no leakage and high dirt-resistance.

Zone valve (characterised control valve), 2-way with internal thread.

For water-side modulating control or shut-off function in heating and air handling systems.

Snap-assembly of the actuator.

Construction type: straight way valve 2-way, DN 15 or DN 20

Connection: internal thread Rp 1/2" (DN 15) or Rp 3/4" (DN 20)

k_v -value: max. 4.8 m³/h, adjustable (DN 15)

k_v -value: max. 8 m³/h, adjustable (DN 20)

Media: Cold and warm water, water with glycol up to max. 50% vol.

Leakage rate A, tight (EN12266-1)

Flow characteristic: equal percentage, optimised in the opening range

Media temperature: +2...+90 °C

Permissible pressure ps: 1600 kPa

Closing pressure dps: 350 kPa

Differential pressure dpmax: 280 kPa

Housing: brass body

Closing element: chrome-plated brass

Stem: brass

Stem seal: O-ring EPDM

Valve seat: PTFE, O-ring EPDM

Manufacture: Belimo

Type: C215Q-J (DN 15)

Type: C220Q-K (DN 20)

2 x Belimo actuator for (PI)QCV

Rotary actuator for zone valves.

Snap-assembly of the actuator, overload protected and without end switches, current reduction in rest position.

Torque motor: 1 Nm

Nominal voltage: AC 24 V 50/60 Hz, DC 24 V

Positioning signal: modulating DC 0...10 V

Operating range: DC 2...10 V

Power consumption:

- in operation: 0,3 W

- in rest position: 0,2 W

- for wire sizing: 0,6 VA

Connection: cable 1 m, 3 x 0.75 mm²

Actuating time: 75 s / 90°

Protection class: III Safety extra-low voltage

Degree of protection: IP40

EMC: CE according to 2004/108/EC

Manufacture: Belimo

Type: CQ24A-SR

Further types available: AC/DC 24 V, AC 230 V, open-close, 3-point, MP-Bus light, with emergency position, ...

2 x Belimo actuator for QCV (open-close)

Rotary actuator for zone valves.
Snap-assembly of the actuator, overload protected and without end switches, current reduction in rest position.

Torque motor: 1 Nm
Nominal voltage: AC 24 V 50/60 Hz, DC 24 V
Control: Open-Close, 3-point
Power consumption:
- in operation: 0,3 W
- in rest position: 0,2 W
- for wire sizing: 0,6 VA
Connection: cable 1 m, 3 x 0.75 mm²
Actuating time: 75 s / 90°
Protection class: III Safety extra-low voltage
Degree of protection: IP40
EMC: CE according to 2004/108/EC

Manufacture: Belimo
Type: CQ24A

Also available as 230 volt version --> CQ230A

Including electrical/mechanical connections and accessories.

5 years of product warranty

Short tender specification

2 x Belimo PIQCV: pressure-independent 2-way zero-leaking valve with adjustable flow rate setting, DN 15 or DN 20, with actuator
2 x Belimo QCV: 2-way zero-leaking valve with adjustable k_v setting, DN 15 or DN 20, with actuator

Belimo – features and benefits

Feature	Benefit
Pressure-independent	Quick and safe valve selection according to flow rate, no calculation of k_v
	Ideal room comfort due to correct flow rate at any time
Automatic and permanent hydraulic balancing	Fast commissioning, no balancing valves needed
Compact size	Maximum efficiency in space and high design freedom
Zero-leaking valve	Circulation and energy losses are eliminated
Self-cleaning ball valve	Outstanding resistance to contamination, smooth operation even after prolonged closures
Equal percentage flow characteristic without inlet jump	Perfect controllability, even in part load situations
Variable V'_{max} setting	Highest flexibility during planning, installation and use phase
Low power consumption actuator	Energy costs reduced by up to 90% compared to conventional zone valves

4.1.1 Fan coil

Self-balanced variable-flow 4-pipe system
4

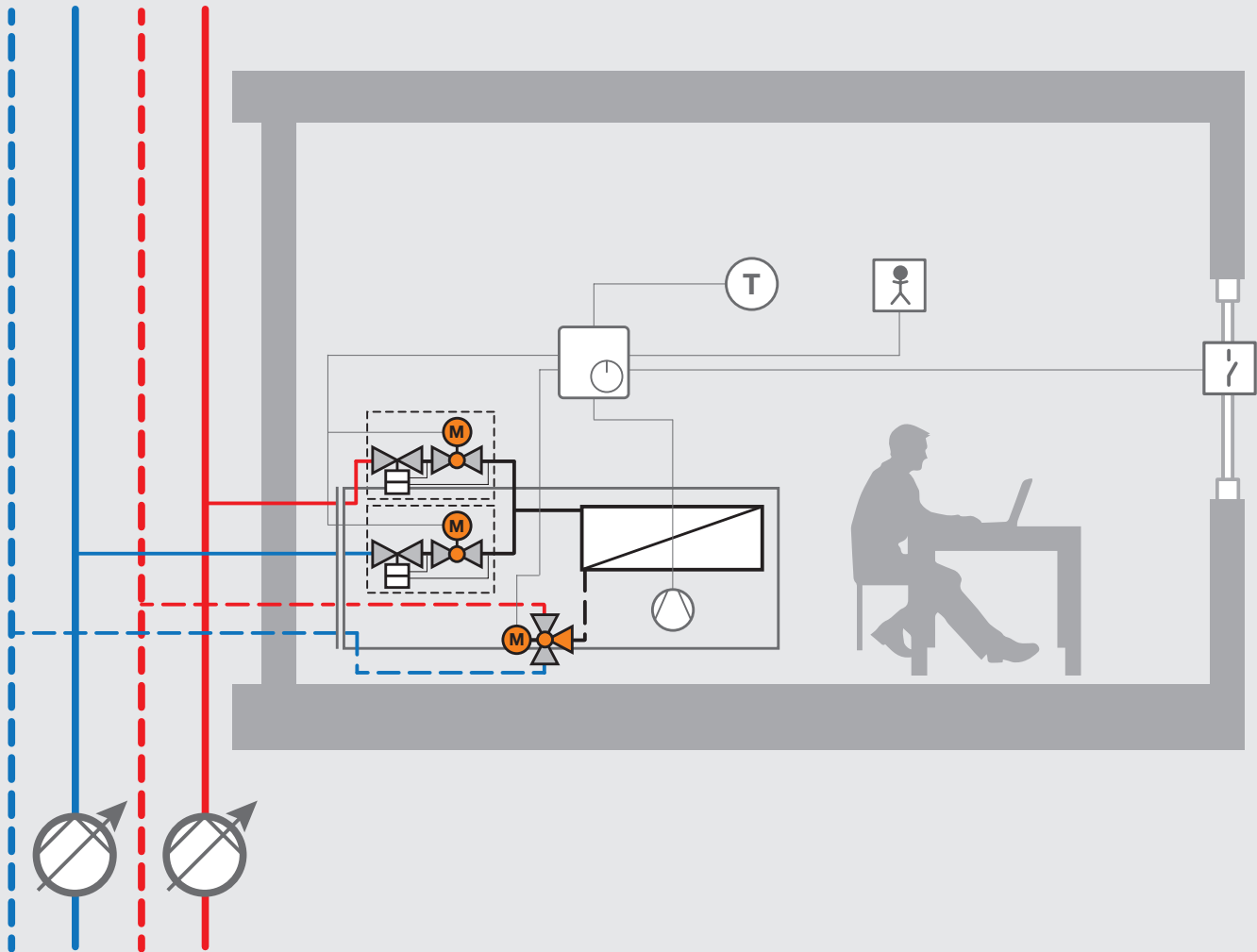

Example illustration

Circuit functions

- Thermal power (heating and cooling) supplied by means of fan coil with one heat exchanger
- 4-pipe system ensures the immediate availability of hot and chilled water
- 4-pipe system allows the cooling of some rooms while heating others
- Permanent hydraulic balancing (in any load condition) of the water flow achieved by the pressure-independent control valve
- Pump with variable speed depending on the differential pressure in the system's most disadvantaged circuit
- Flow rate and fan speed adjusted by the room temperature controller
- Type of control of the actuator (control): 3-point, modulating or Bus
- Type of control of the actuator (change-over heating/cooling): Open-close or Bus
- Optional functions: presence monitoring, window monitoring

Controller

Room temperature controller with:

- fan speed variation (3 speeds with 3 DO or modulating with 1 AO)
- water flow variation for hot and cold sequence with 2 controls 0...10 V or 3-point or via Bus
- hot sequence - cold sequence division with 1 control (change-over)

Optional: Integration of signal from a presence detector and/or window contact switch

Bill of material

Typ	Description	Quantity	Costs
C2..QP(T)-..	Belimo pressure-independent 2-way zone valve PIQCV, DN .. with adjustable V'_{max} ...-... l/h	2	
CQ2..	Belimo rotary actuator for zone valves, ... V, control:	2	
EXT-OC-ZQ..-P(T)	Optional: Insulation for C2..QP(T) valve, 2-way, DN ..	2	
C3..Q..	Belimo 3-way zone valve QCV, DN .. , change-over	1	
CQ24A	Belimo rotary actuator for zone valves, 24 V, control: Open-close (*)	1	
EXT-OC-ZR-C3..Q-..	Optional: Insulation for C3..Q valve, 3-way, DN ..	1	
ZR23..	Optional: Pipe connector for zone valve DN ..	7	
	Room temperature controller, 2 analogue outputs, 1 digital outputs	1	
	Temperature sensor	1	
	Optional sensor: presence detector, window contact switch, ...		

(*) also available as 230 volt version --> CQ230A

Extended tender specification

Supply and installation of kit for fan coil consisting of:

2 x Belimo PIQCV (Pressure-Independent-Quick-Compact-Valve)

Supply and installation of pressure-independent 2-way valve with automatic permanent hydraulic balancing, equal percentage characteristic curve, no leakage and high dirt-resistance.

Pressure independent zone valve (characterised control valve), 2-way with internal thread.

For water-side modulating control in heating and air handling systems.

Snap-assembly of the actuator, pressure-reducing valve for constant flow rate independently from pressure variations.

With measuring ports for verification of pressure value (optional version).

Construction type: straight way valve 2-way, DN 15 or DN 20

Connection: internal thread Rp 1/2" (DN 15) or Rp 3/4" (DN 20)

Flow rate V_{max} : max. 210 l/h, adjustable [C215QP(T)-B]

Flow rate V_{max} : max. 420 l/h, adjustable [C215QP(T)-D]

Flow rate V_{max} : max. 980 l/h, adjustable [C220QP(T)-F]

Media: Cold and warm water, water with glycol up to max. 50% vol.

Leakage rate A, tight (EN12266-1)

Flow characteristic: equal percentage (VDI/VDE 2178), optimised in the opening range

Media temperature: +2...+90 °C

Permissible pressure ps: 1600 kPa

Closing pressure dps: 700 kPa

Pressure value: 16...350 kPa

Housing: brass body

Closing element: stainless steel

Stem: stainless steel

Stem seal: O-ring EPDM

Valve seat: PTFE, O-ring EPDM

Diaphragm: EPDM

Manufacture: Belimo

Type: C215QP(T)-B (DN 15, 210 l/h)

Type: C215QP(T)-D (DN 15, 420 l/h)

Type: C220QP(T)-F (DN 20, 980 l/h)

(T) = Version with measuring ports

Self-balanced variable-flow 4-pipe system

1 x Belimo QCV (Quick-Compact-Valve)

Supply and installation of 3-way change-over valve with high dirt-resistance.

3-way change-over zone valve with internal thread for switching functions in air handling units and heating systems.

Construction type: 3-way change-over valve, DN 15 or DN 20
 Connection: internal thread Rp 1/2" (DN 15) or Rp 3/4" (DN 20)
 k_{VS} value: 2.5 m³/h (DN 15) / 4 m³/h (DN 20)
 Media: Cold and warm water, water with glycol up to max. 50% vol.
 Media temperature: +2...+90 °C
 Permissible pressure ps: 1600 kPa
 Closing pressure dps: 350 kPa
 Differential pressure dpmax: 280 kPa

Housing: brass body
 Closing element: chrome-plated brass
 Stem: brass
 Stem seal: O-ring EPDM
 Valve seat: PTFE, O-ring EPDM

Manufacture: Belimo
 Type: C315Q-H (DN 15)
 Type: C320Q-J (DN 20)

4

2 x Belimo actuator for (PI)QCV

Rotary actuator for zone valves.

Snap-assembly of the actuator, overload protected and without end switches, current reduction in rest position.

Torque motor: 1 Nm
 Nominal voltage: AC 24 V 50/60 Hz, DC 24 V
 Positioning signal: modulating DC 0...10 V
 Operating range: DC 2...10 V
 Power consumption:
 - in operation: 0,3 W
 - in rest position: 0,2 W
 - for wire sizing: 0,6 VA
 Connection: cable 1 m, 3 x 0.75 mm²
 Actuating time: 75 s / 90°
 Protection class: III Safety extra-low voltage
 Degree of protection: IP40
 EMC: CE according to 2004/108/EC

Manufacture: Belimo
 Type: CQ24A-SR

Further types available: AC/DC 24 V, AC 230 V, open-close, 3-point, MP-Bus light, with emergency position, ...

1 x Belimo actuator for QCV (open-close)

Rotary actuator for zone valves.
Snap-assembly of the actuator, overload protected and without end switches, current reduction in rest position.

Torque motor: 1 Nm
Nominal voltage: AC 24 V 50/60 Hz, DC 24 V
Control: Open-Close, 3-point
Power consumption:
- in operation: 0,3 W
- in rest position: 0,2 W
- for wire sizing: 0,6 VA
Connection: cable 1 m, 3 x 0.75 mm²
Actuating time: 75 s / 90°
Protection class: III Safety extra-low voltage
Degree of protection: IP40
EMC: CE according to 2004/108/EC

Manufacture: Belimo
Type: CQ24A

Also available as 230 volt version --> CQ230A

Including electrical/mechanical connections and accessories.

5 years of product warranty

Short tender specification

2 x Belimo PIQCV: pressure-independent 2-way zero-leaking valve with adjustable flow rate setting, DN 15 or DN 20, with actuator
1 x Belimo QCV: 3-way change-over valve, DN 15 or DN 20, with actuator

Belimo – features and benefits

Feature	Benefit
Pressure-independent	Quick and safe valve selection according to flow rate, no calculation of k_v
	Ideal room comfort due to correct flow rate at any time
Automatic and permanent hydraulic balancing	Fast commissioning, no balancing valves needed
Compact size	Maximum efficiency in space and high design freedom
Zero-leaking valve	Circulation and energy losses are eliminated
Self-cleaning ball valve	Outstanding resistance to contamination, smooth operation even after prolonged closures
Equal percentage flow characteristic without inlet jump	Perfect controllability, even in part load situations
Variable V'_{max} setting	Highest flexibility during planning, installation and use phase
Low power consumption actuator	Energy costs reduced by up to 90% compared to conventional zone valves

4.2 Floor heating (with cooling)

Self-balanced variable-flow 4-pipe system

4

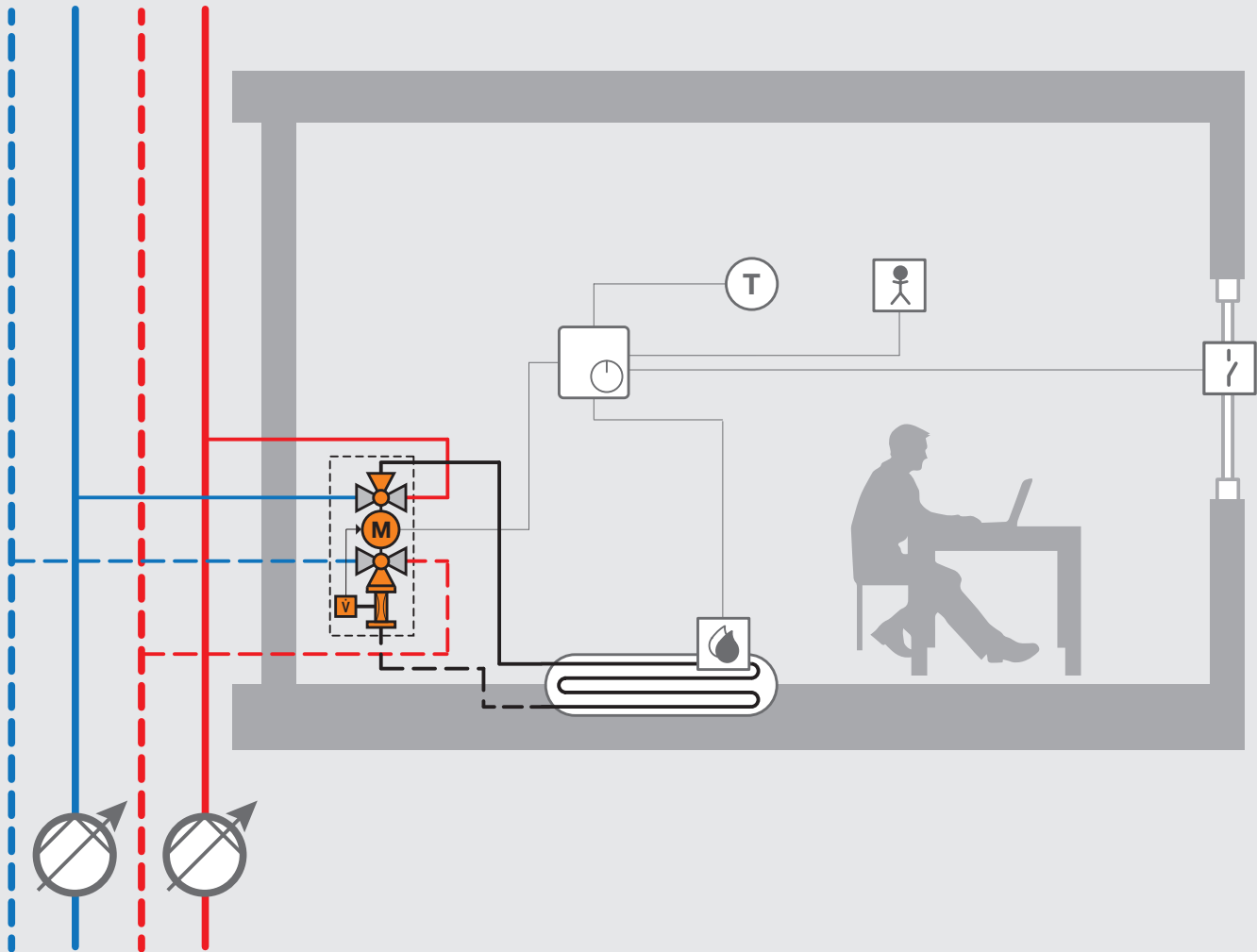

Example illustration

Circuit functions

- Thermal power supplied by means of floor-mounted or wall-mounted heating elements
- 4-pipe system ensures the immediate availability of hot and chilled water
- 4-pipe system allows the cooling of some rooms while heating others
- Permanent hydraulic balancing (in any load condition) of the water flow achieved by the pressure-independent control valve
- Pump with variable speed depending on the differential pressure in the system's most disadvantaged circuit
- Flow rate adjusted by the room temperature controller
- Automatic shut-off if the temperature falls below the dew point
- Automatic shut-off in the event of an open window
- Type of control of the actuator: modulating or Bus
- Optional functions: presence monitoring, windows monitoring

Controller

Room temperature controller with:

- modulating (0...10 V) water flow variation
- valve shut-off upon signal from dew-point sensor
- valve shut-off upon window contact signal

Optional: Integration of signal from a presence detector

Bill of material

Typ	Description	Quantity	Costs
EP0..R-R6+SR	Belimo electronic pressure-independent 6-way zone valve DN ..	1	
EXT-OC-ZR30..	Optional: Insulation for 6-way valve, DN ..	1	
ZR23..	Optional: Pipe connector for zone valve DN ..	6	
ZR-004	Optional: Fastening angle for 6-way valve DN 15 + DN 20	1	
	Room temperature controller	1	
	Temperature sensor	1	
	Dew-point sensor	1	
	Optional sensors: presence detector, window contact switch, ...		

Extended tender specification

Belimo 6-way EPIV

Supply and installation of electronic pressure-independent 6-way zone valve with automatic permanent hydraulic balancing, no leakage and high dirt-resistance.

Zone valve, 6-way characterised control valve with sensor-operated flow control.

For water-side switching or modulating control of thermal heating/cooling elements, with integrated pressure relief function.

Consisting of 6-way valve with actuator and measuring pipe with volumetric flow sensor, parametrisable with ZTH EU.

Construction type: 6-way valve, DN 15 or DN 20

Connection: internal thread Rp 1/2" (DN 15) or Rp 3/4" (DN 20)

V_{nom} Sequence 1: 21 l/min (DN 15) / 39 l/min (DN 20)

V_{nom} Sequence 2: 21 l/min (DN 15) / 39 l/min (DN 20)

Flow rate V_{max} 1.1...21 l/min, adjustable (5-100% of V_{nom}) (DN 15)

Flow rate V_{max} 2...39 l/min, adjustable (5-100% of V_{nom}) (DN 20)

Media: Cold and warm water, water with glycol up to max. 50% vol.

Leakage rate A, air-bubble-tight (EN12266-1)

Flow characteristic: linear

- Sequence 1: 2...4.7 V (Cooling recommended)

- Dead zone: 4.7...7.3 V

- Sequence 2: 7.3...10 V (Heating recommended)

Media temperature: +6...+80 °C

Permissible pressure ps: 1600 kPa

Differential pressure dpmax: 100 kPa

Theoretical k_{VS} value: 1.2 m³/h (DN 15) / 2.3 m³/h (DN 20)

Torque motor: 5 Nm

Nominal voltage: AC 24 V 50/60 Hz, DC 24 V

Positioning signal: DC 0...10 V

Operating range: DC 2...10 V

Position feedback: DC 2...10 V

Power consumption:

- in operation: 4 W

- in rest position: 4 W

- for wire sizing: 6.5 VA

Connection: cable 1 m, 4 x 0.75 mm²

Manual override: with push-button

Protection class: III Safety extra-low voltage

Degree of protection: IP54

EMC: CE according 2004/108/EC

Self-balanced variable-flow 4-pipe system

Measuring principle: ultrasonic flow measurement
 Measuring accuracy: +/- 6% (of 25...100% V_{nom})
 Control accuracy: +/- 10% (of 25...100% V_{nom})
 Min. controllable flow rate: 1% of V_{nom}

Housing: brass body nickel-plated
 Closing element: chrome-plated brass
 Stem: nickel-plated brass
 Stem seal: O-ring EPDM
 Valve seat: PTFE, O-ring EPDM
 Measuring pipe: brass body nickel-plated

Manufacture Belimo
 Type: EP015R-R6+SR (DN 15)
 Type: EP020R-R6+SR (DN 20)

Including electrical/mechanical connections and accessories.

5 years of product warranty

Short tender specification

Belimo 6-way electronic pressure independent zero-leaking zone valve, DN 15 or DN 20, device consisting of valve, flow measurement sensor and actuator

Belimo – features and benefits

Feature	Benefit
Pressure-independent	Quick and safe valve selection according to flow rate, no calculation of k_v
	Ideal room comfort due to correct flow rate at any time
Automatic and permanent hydraulic balancing	Fast commissioning, no balancing valves needed
Air-bubble tight valve	Circulation and energy losses are eliminated
Self-cleaning ball valve	Outstanding resistance to contamination, smooth operation even after prolonged closures
Replaces four straight-through valves	Reduced expense for planning, installation and operation Eliminates installation errors Requires only one control sequence
Integrated pressure relief function	Maximum plant safety
Different V'_{max} -values for sequences 1 and 2	Enables optimum design of the cooling and heating circuit

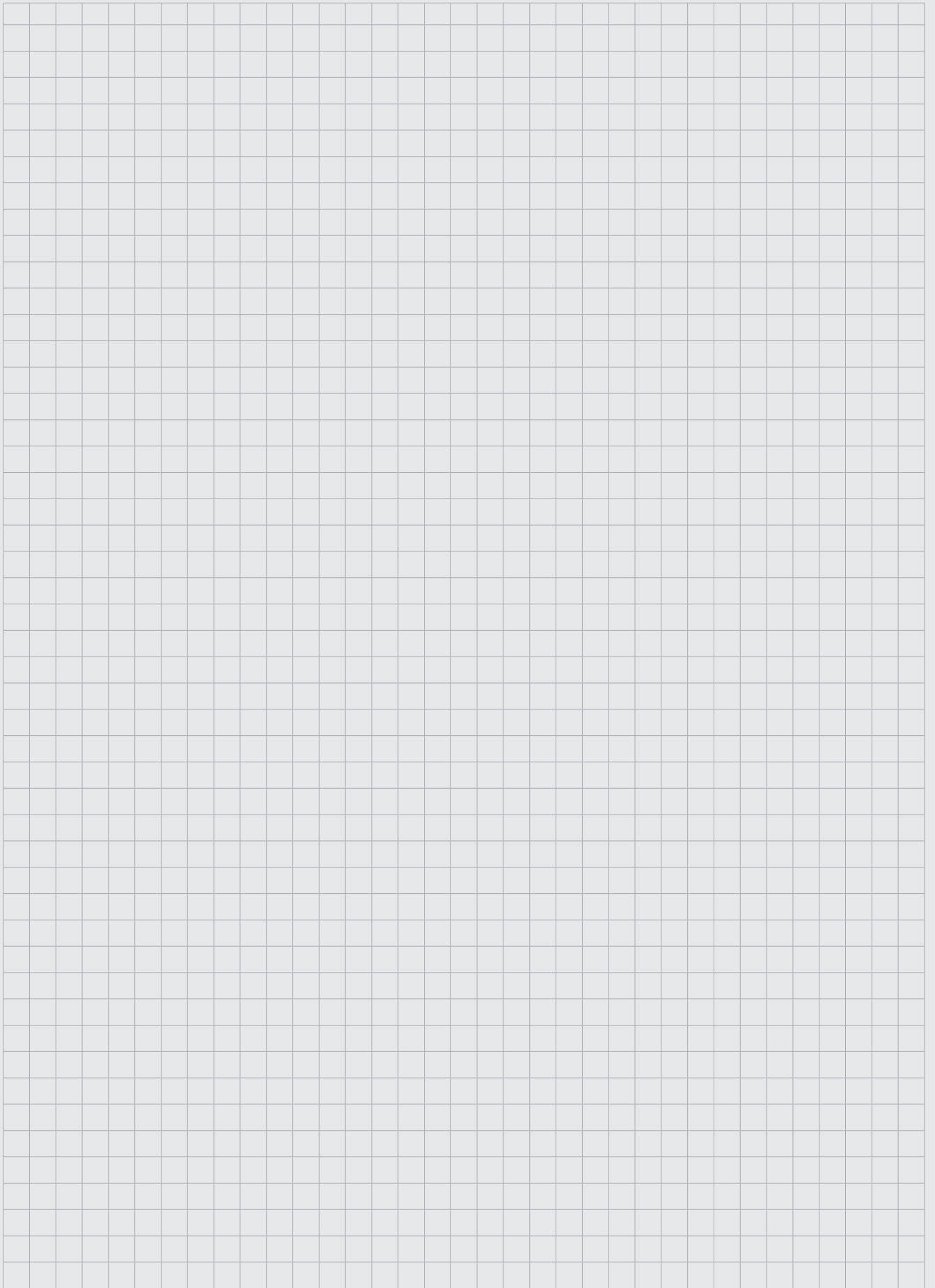

4.3 Heating- and cooling ceiling

Self-balanced variable-flow 4-pipe system

4

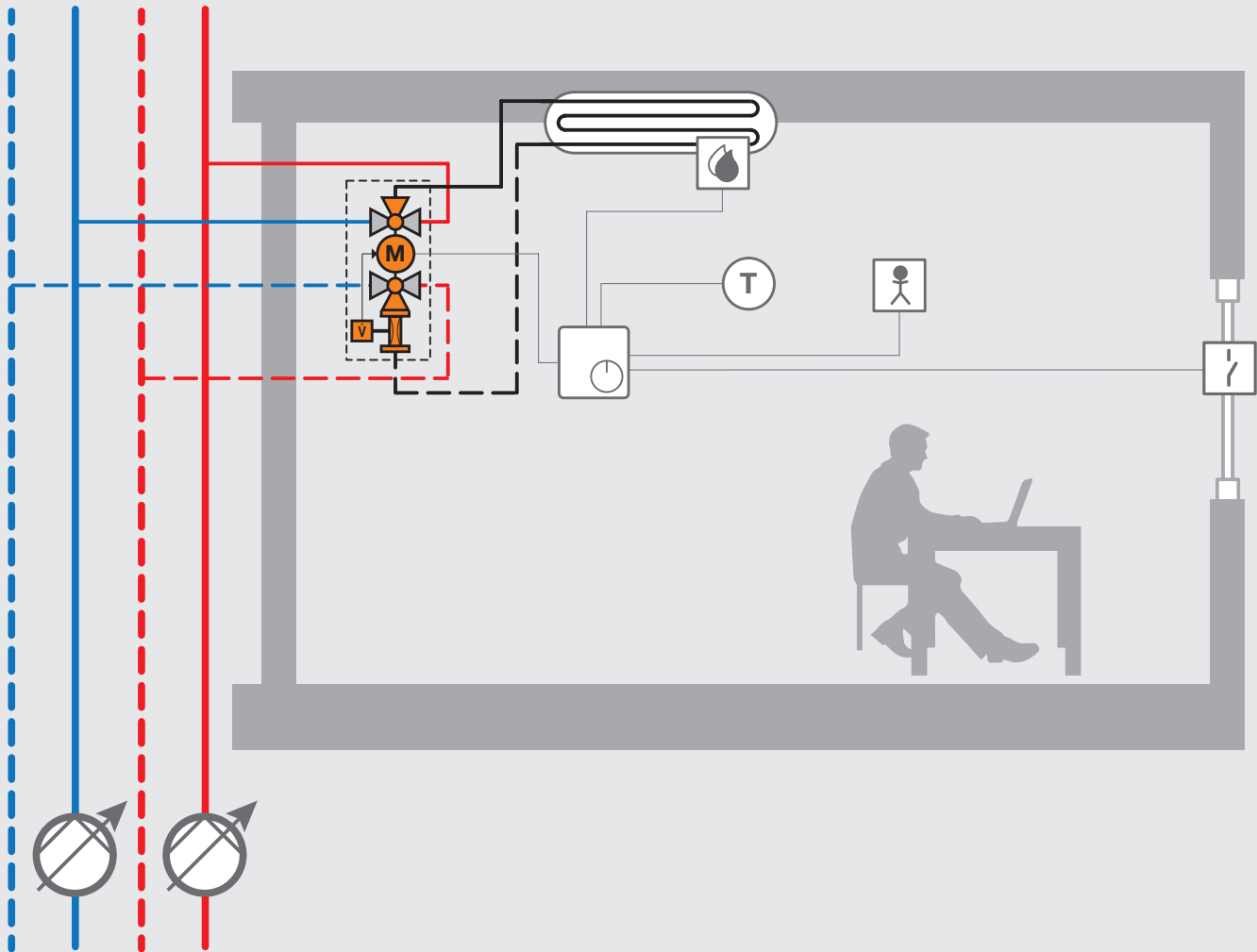

Example illustration

Circuit functions

- Thermal power supplied by chilled/heated ceiling
- 4-pipe system ensures the immediate availability of hot and chilled water
- 4-pipe system allows the cooling of some rooms while heating others
- Permanent hydraulic balancing (in any load condition) of the water flow achieved by the pressure-independent control valve
- Pump with variable speed depending on the differential pressure in the system's most disadvantaged circuit
- Flow rate adjusted by the room temperature controller
- Automatic shut-off if the temperature falls below the dew point
- Automatic shut-off in the event of an open window
- Type of control of the actuator: modulating
- Optional functions: presence monitoring

Controller

Room temperature controller with:

- modulating (0...10 V) water flow variation
- valve shut-off upon signal from dew-point sensor
- valve shut-off upon window contact signal

Optional: Integration of signal from a presence detector

Bill of material

Typ	Description	Quantity	Costs
EP0..R-R6+SR	Belimo electronic pressure-independent 6-way zone valve DN ..	1	
EXT-OC-ZR30..	Optional: Insulation for 6-way valve, DN ..	1	
ZR23..	Optional: Pipe connector for zone valve DN ..	6	
ZR-004	Optional: Fastening angle for 6-way valve DN 15 + DN 20	1	
	Room temperature controller	1	
	Temperature sensor	1	
	Dew-point sensor	1	
	Optional sensors: presence detector, window contact switch, ...		

Extended tender specification

Belimo 6-way EPIV

Supply and installation of electronic pressure-independent 6-way zone valve with automatic permanent hydraulic balancing, no leakage and high dirt-resistance.

Zone valve, 6-way characterised control valve with sensor-operated flow control.

For water-side switching or modulating control of thermal heating/cooling elements, with integrated pressure relief function.

Consisting of 6-way valve with actuator and measuring pipe with volumetric flow sensor, parametrisable with ZTH EU.

Construction type: 6-way valve, DN 15 or DN 20

Connection: internal thread Rp 1/2" (DN 15) or Rp 3/4" (DN 20)

V_{nom} Sequence 1: 21 l/min (DN 15) / 39 l/min (DN 20)

V_{nom} Sequence 2: 21 l/min (DN 15) / 39 l/min (DN 20)

Flow rate V_{max} 1.1...21 l/min, adjustable (5-100% of V_{nom}) (DN 15)

Flow rate V_{max} 2...39 l/min, adjustable (5-100% of V_{nom}) (DN 20)

Media: Cold and warm water, water with glycol up to max. 50% vol.

Leakage rate A, air-bubble-tight (EN12266-1)

Flow characteristic: linear

- Sequence 1: 2...4.7 V (Cooling recommended)

- Dead zone: 4.7...7.3 V

- Sequence 2: 7.3...10 V (Heating recommended)

Media temperature: +6...+80 °C

Permissible pressure ps: 1600 kPa

Differential pressure dpmax: 100 kPa

Theoretical k_{VS} value: 1.2 m³/h (DN 15) / 2.3 m³/h (DN 20)

Torque motor: 5 Nm

Nominal voltage: AC 24 V 50/60 Hz, DC 24 V

Positioning signal: DC 0...10 V

Operating range: DC 2...10 V

Position feedback: DC 2...10 V

Power consumption:

- in operation: 4 W

- in rest position: 4 W

- for wire sizing: 6.5 VA

Connection: cable 1 m, 4 x 0.75 mm²

Manual override: with push-button

Protection class: III Safety extra-low voltage

Degree of protection: IP54

EMC: CE according 2004/108/EC

Self-balanced variable-flow 4-pipe system

Measuring principle: ultrasonic flow measurement
 Measuring accuracy: +/- 6% (of 25...100% V_{nom})
 Control accuracy: +/- 10% (of 25...100% V_{nom})
 Min. controllable flow rate: 1% of V_{nom}

Housing: brass body nickel-plated
 Closing element: chrome-plated brass
 Stem: nickel-plated brass
 Stem seal: O-ring EPDM
 Valve seat: PTFE, O-ring EPDM
 Measuring pipe: brass body nickel-plated

Manufacture Belimo
 Type: EP015R-R6+SR (DN 15)
 Type: EP020R-R6+SR (DN 20)

Including electrical/mechanical connections and accessories.

5 years of product warranty

Short tender specification

Belimo 6-way electric pressure independent zero-leaking zone valve, DN 15 or DN 20, device consisting of valve, flow measurement sensor and actuator

Belimo – features and benefits

Feature	Benefit
Pressure-independent	Quick and safe valve selection according to flow rate, no calculation of k_v
	Ideal room comfort due to correct flow rate at any time
Automatic and permanent hydraulic balancing	Fast commissioning, no balancing valves needed
Air-bubble tight valve	Circulation and energy losses are eliminated
Self-cleaning ball valve	Outstanding resistance to contamination, smooth operation even after prolonged closures
Replaces four straight-through valves	Reduced expense for planning, installation and operation Eliminates installation errors Requires only one control sequence
Integrated pressure relief function	Maximum plant safety
Different V'_{max} -values for sequences 1 and 2	Enables optimum design of the cooling and heating circuit

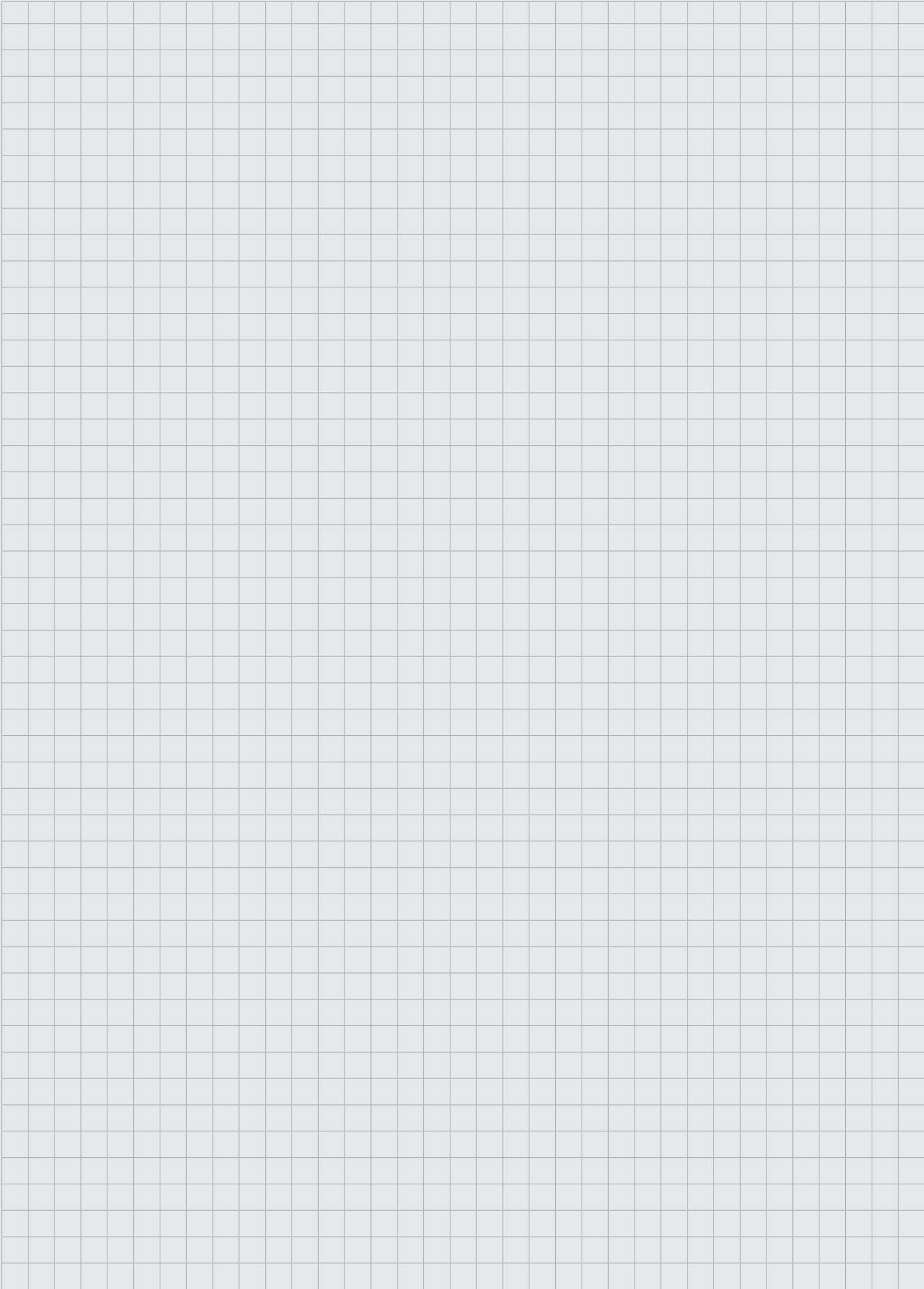

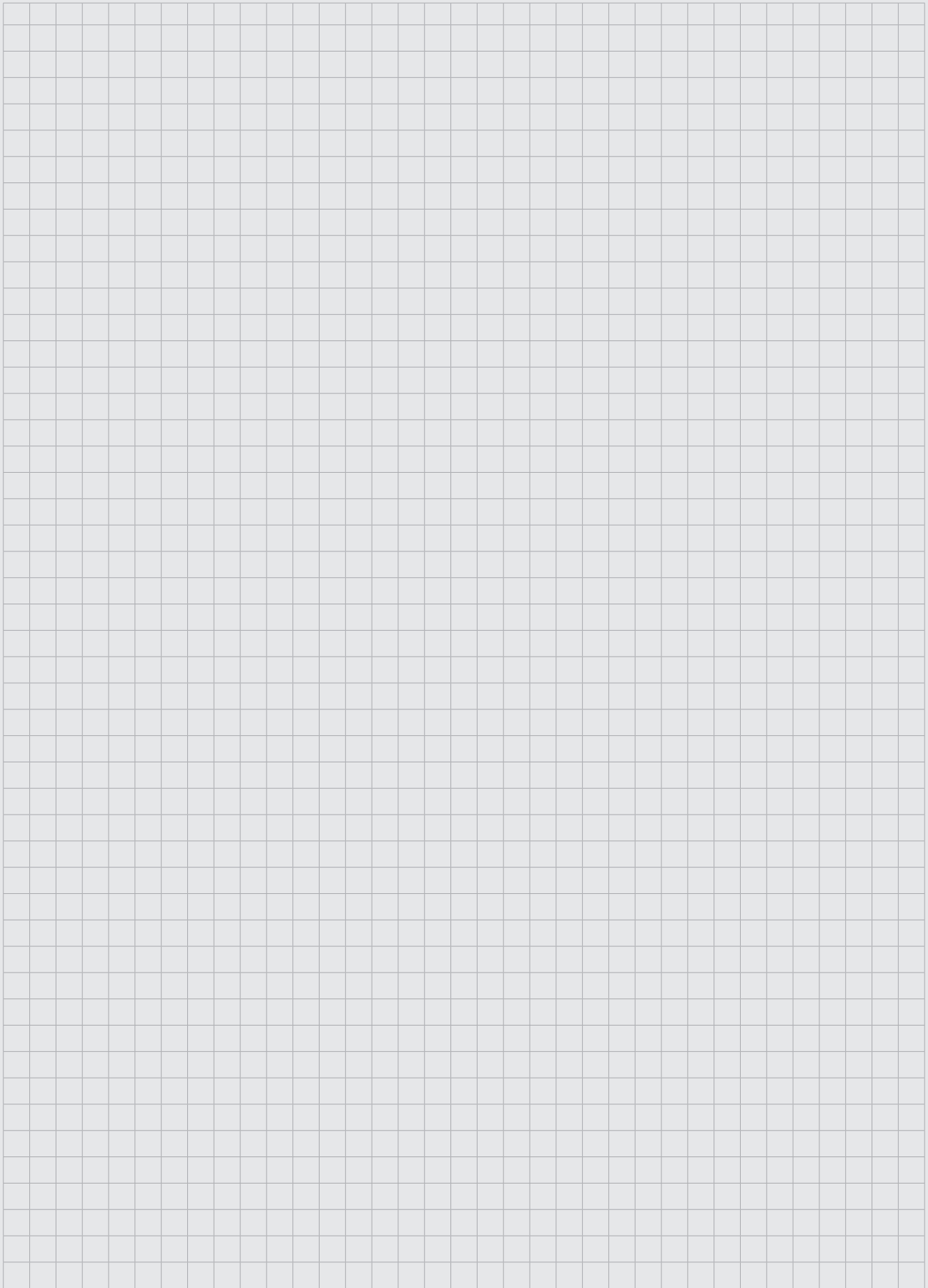

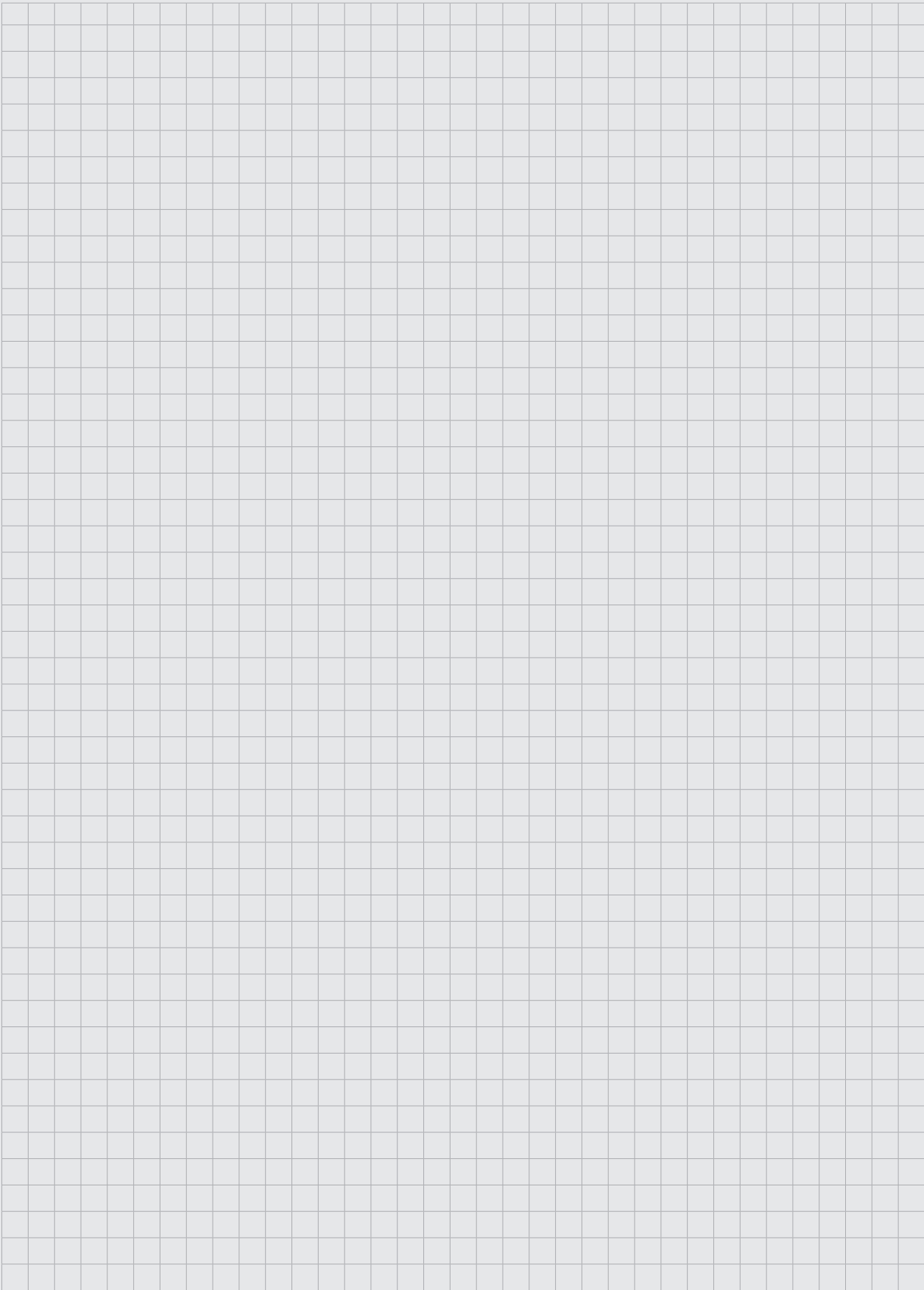

In your vicinity – Everywhere

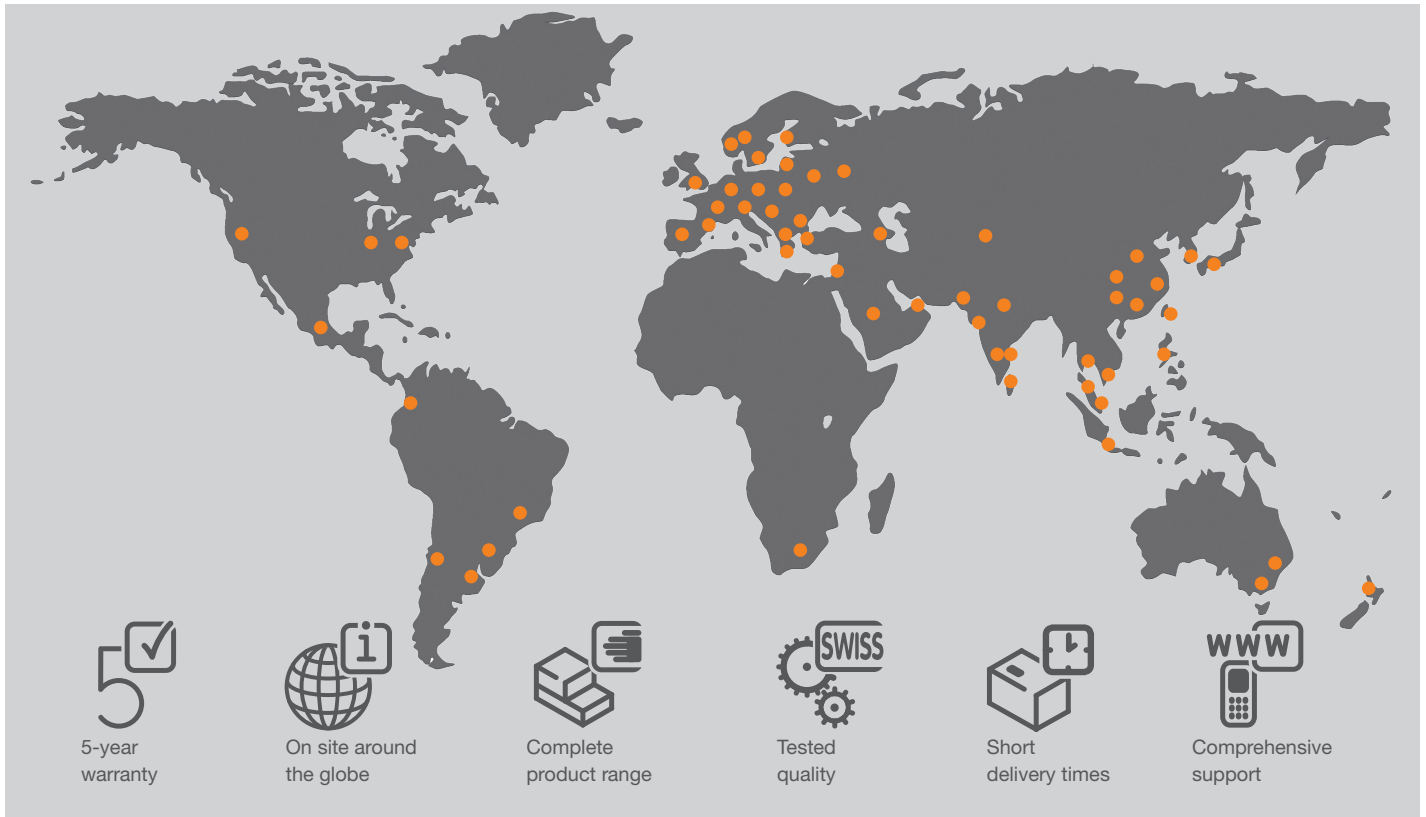

The image features a world map with numerous orange dots scattered across all continents, indicating a global presence. Below the map are six icons, each with a corresponding text label:

- 5-year warranty**: Represented by a large number '5' and a checkmark icon.
- On site around the globe**: Represented by a globe icon and an information 'i' icon.
- Complete product range**: Represented by an icon of stacked boxes and a hand holding a document.
- Tested quality**: Represented by two interlocking gears and the word 'SWISS' in a box.
- Short delivery times**: Represented by a box icon and a clock icon.
- Comprehensive support**: Represented by the letters 'WWW' in a box and a mobile phone icon.

BELIMO Automation AG
Brunnenbachstrasse 1
CH-8340 Hinwil, Switzerland

Tel. +41 43 843 61 11
Fax +41 43 843 62 68
info@belimo.ch
www.belimo.eu

EN - 11.2015 - Subject to technical modifications