

Coupling piece Z-KS2

- Comprising:
- 1 forkhead
 - 1 axial joint with female thread M6
 - 1 double safety bolt
 - 1 safety clamp
- Galvanized steel

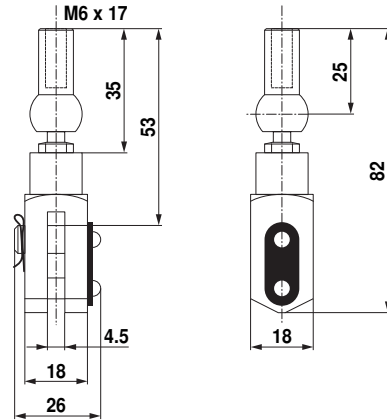
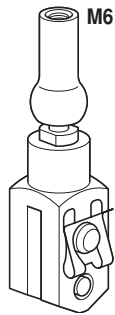

Note

Consider possible actuation force losses !



Rotary support Z-DS1

- Comprising:
- 1 basic plate with thread M6
 - 2 cylinderscrews M6 x 10
 - 1 bearing bolt
- Galvanized steel

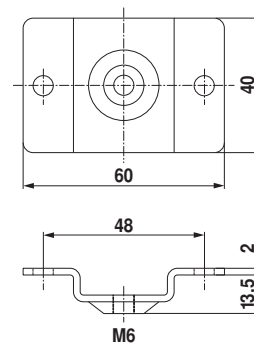
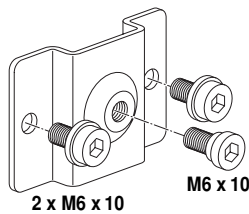

Mechanical limiter set Z-AS2

- Comprising:
- 1 mechanical limiter LH
 - 1 cylinderscrew M3 x 5 (Torx)

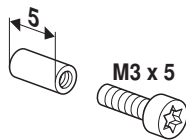

Attention

Only for open-close and MF types !



Packaging unit: 20 pieces

Terminal protection Z-TP

- Protection IP54 for actuators with terminals, incl. cable sealing set

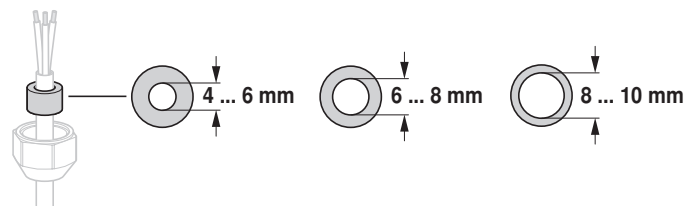
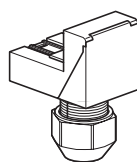

Packaging unit: 20 pieces