

2-way and 3-way characterised control valves

Table of contents

Introduction

The Belimo characterised control valve	2
Project planning	3
Design and dimensioning	3
Flow characteristics	4

Design and dimensioning

2-way and 3-way characterised control valves R2.. / R3.. / R6..R / R7..R	5
2-way and 3-way characterised control valves R4..(K) / R5..(K)	6
2-way characterised control valves R6..W..-S8	7
2-way characterised control valves R4..D(K)	8
Characterised control valve selection table	10
Dimensioning and selection table for 2-way and 3-way open-close ball valves	11

The Belimo characterized control valve

Ordinary ball valves are unsuitable as control devices

In order to ensure good stability of control, a hydraulic final controlling element must possess a flow characteristic that supplements the non-linear characteristic of the heat exchanger in the HVAC system.

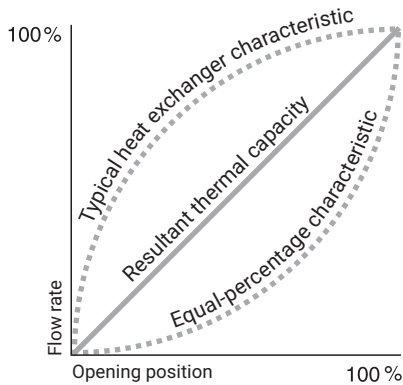

Characteristics of an ideal hydraulic final controlling element

An equal-percentage valve characteristic is desirable in order to produce a linear relationship between the thermal output and the opening position of the final controlling element. This means that the flow rate increases very slowly as the final controlling element begins to open. Unfortunately, this characteristic is severely distorted in ordinary ball valves.

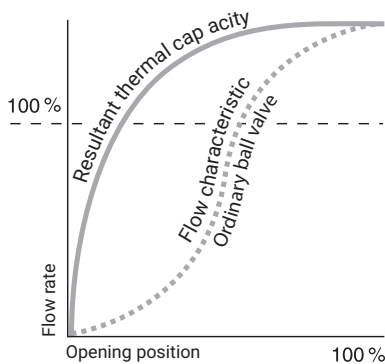

Characteristic of an ordinary ball valve

The reason for this is that an ordinary ball valve has an extremely high flow coefficient (k_{VS} value) compared with its nominal size, several times that of a comparable globe valve.

Therefore, an ordinary ball valve is not very suitable for performing control functions:

- Flow coefficient excessive due to the design
- Flow control inadequate in the part-load range

Belimo adds «characterized control» to ball valves

Belimo has succeeded in solving the problem of the distorted flow characteristic of ordinary ball valves.

A so-called «characterizing disc» in the inlet of the characterized control valve converts the valve's characteristic to the equal-percentage kind.

The side of the characterizing disc facing the ball is concave and in contact with the surface of the ball. Thus, the actual flow is regulated by the hole in the ball and by the V-shaped aperture in the characterizing disc.

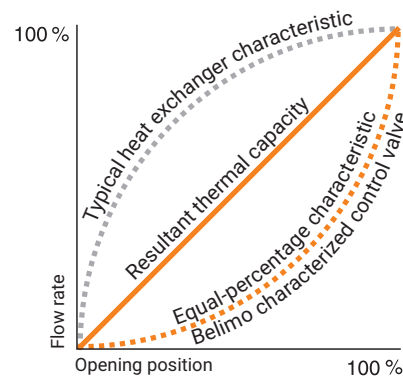

Characteristic of a Belimo characterized control valve

The k_{VS} value is reduced and corresponds approximately to that of a globe valve of comparable size. In order to avoid having to fit pipe reducers in the majority of cases, each valve size is also available with an appropriate choice of k_{VS} values.

Advantages of the Belimo characterized control valve

- Equal-percentage characteristic
- No initial jump in flow on opening
- Excellent stability of control thanks to the characterizing disk

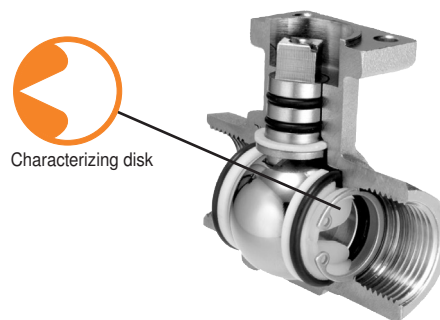

- k_{VS} values similar to those of globe valves of comparable size
- Fewer pipe reducers needed
- Better part-load characteristics and less prone to vibration, greater stability of control
- Tight-sealing (2-way)

Elements of the characterized control valve

- 1 Simple direct mounting using a central screw. The rotary actuator can be mounted in four different positions
- 2 Square stem head for form-fit attachment of the rotary actuator
- 3 Identical mounting flange for all sizes
- 4 Stem with two O-ring seals for a long service life

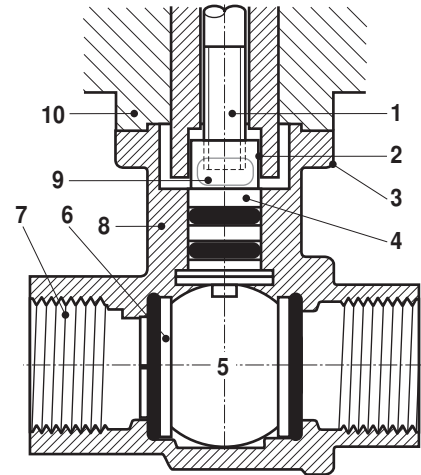

- 5 Ball and stem made of stainless steel or chrome-plated brass
- 6 Characterizing disc produces equal-percentage flow characteristic
- 7 Internal thread connection (ISO 7-1), external thread connection (ISO 228-1) and flange connection (ISO 7005-1/2)
- 8 Forged fitting, nickel-plated brass body
- 9 Vent window to prevent the accumulation of condensation
- 10 Thermal decoupling of the actuator from the ball valve

Optimum choice of k_{VS} valves of identical size

- Better controllability
- Lower installation costs

The Belimo range of characterized control valves includes 2-way and 3-way types. These are available in a variety of sizes and with a choice of k_{VS} values.

A characterized control valve is supplied as a unit complete with a suitable Belimo rotary actuator.

Project planning

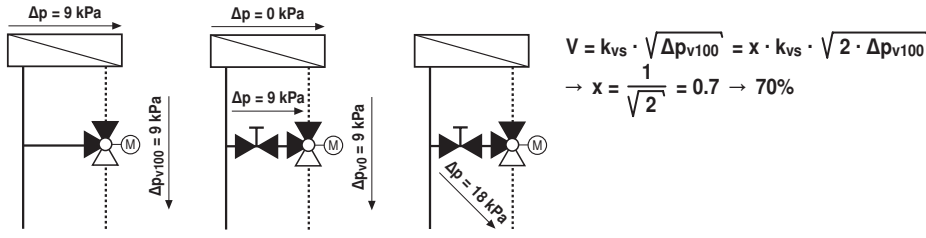
Relevant information	The data, information and limit values listed on the "Characterised control valves" data sheets are to be taken into account and/or complied with, respectively.
Closing and differential pressures	The maximum permissible closing and differential pressures can be found in the data sheets.
Pipeline clearances	The minimum clearances between the pipelines and the walls and ceilings required for project planning depend not only on the valve dimensions but also on the selected actuator and can be found in the data sheets of the valves and actuators.
2-way characterised control valves	Characterised control valves are to be installed in the return as throttling devices. This leads to lower thermal loads on the sealing elements in the valve. The prescribed flow direction must be observed.
3-way characterised control valves	3-way characterised control valves are mixing devices. The flow direction must be observed for all pressure levels. Installation in the supply or return is dependent on the selected hydraulic circuit. The 3-way characterised control valve may not be used as a diverting valve
Diverting circuit	Thanks to the reduced flow rate in the bypass, no balancing valve in the bypass line is necessary with the diverting circuit.
Bypass 70% k_{VS}	<p>Full load Zero load with bypass throttle Zero load with reduced bypass k_{VS}</p>  <p style="text-align: right;">$V = k_{VS} \cdot \sqrt{\Delta p_{V100}} = x \cdot k_{VS} \cdot \sqrt{2 \cdot \Delta p_{V100}}$ $\rightarrow x = \frac{1}{\sqrt{2}} = 0.7 \rightarrow 70\%$</p>
Water quality	The water quality requirements specified in VDI 2035 must be adhered to.
Dirt filter	Characterised control valves are regulating devices. The use of dirt filters is recommended in order to prolong their service life as modulating instruments.
Shut-off devices	Care must be taken to ensure that sufficient numbers of shut-off devices are installed.

Design and dimensioning

Control characteristics	<p>In order to ensure that a valve achieves good control characteristics, thus making it possible to ensure a long service life for the final controlling element, proper configuration of the valve with the correct valve authority is required.</p> <p>The valve authority P_V is the measure of the control characteristics of the valve in conjunction with the hydraulic network. The valve authority is the ratio between the differential pressure of the completely opened valve at the nominal flow rate and the maximum differential pressure occurring with the closed valve. The greater the valve authority, the better the control characteristics. The smaller the valve authority P_V becomes, the more the operational behaviour of the valve will deviate from the linearity, i.e. the poorer the behaviour of the volumetric flow control. A valve authority of P_V of >0.5 is strived for in everyday practice.</p>
Design for use with glycol	<p>Salts were formerly added to the water to reduce its freezing point; this was referred to as brine applications. Nowadays, glycols are used and one speaks of refrigerant agents. Depending on the concentration of the refrigerant agent (type of glycol) used and the medium temperature, the density of the water/glycol mixture varies from 1% to 9%. The volumetric deviation which results from this process is less than the permitted quantity tolerance of the k_{VS} value of the valve (of $\pm 10\%$ in accordance with VDE 2178) and need not as a rule be taken into account, even if glycols require a slightly elevated k_V value.</p> <p>Depending on the type of glycol, tolerance with the valve materials used must be ensured and the permitted maximum concentration (50 percent) may not be exceeded.</p>

Flow characteristics

2-way characterised control valve

The characteristic curve is equal-percentage, with a characteristic curve factor $n(g) = 3.2$ or 3.9 . This guarantees stable control characteristics in the elevated partial load range. The curve is linear in the lower opening range between $0 \dots 30\%$ operating range. This ensures outstanding control characteristics, including in the lower partial load range. The operating range $0 \dots 100\%$ corresponds to an angle of rotation of $15 \dots 90^\circ$.

The characterised control valves function as tight-closing shut-off devices between angles of rotation of $0 \dots 15^\circ$.

3-way characterised control valve

Same behaviour via the control path A – AB as with the 2-way characterised control valves. The flow rate in the bypass B – AB is designed to be 70% of the k_{VS} value of the control path (A – AB). The characteristic curve in the bypass is linear.

Note

As a result of its ball construction, the 3-way characterised control valve is suitable only to a limited extent for conventional return line temperature controls. It is therefore recommended that return line temperature controls be implemented as double mixing circuits when these characterised control valves are used.

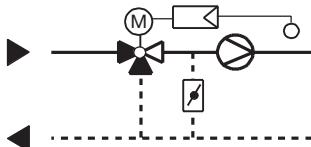

There are no restrictions with air heater mixing circuits or with injection circuits.

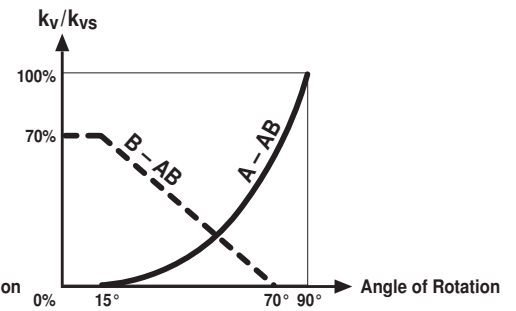
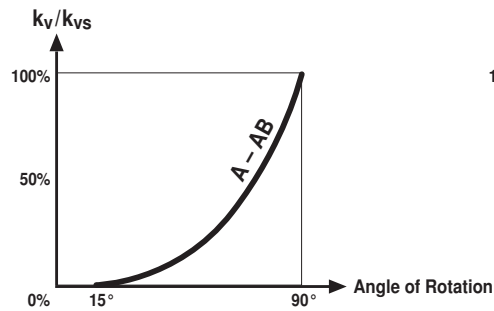

Calculation diagram for 2-way and 3-way characterised control valves R2.. / R3.. / R6..R / R7..R



- Application** These characterised control valves are used in open (R2.. und R6..R) and closed cold and hot water systems for modulating water-side control of air treatment and heating plants.
- Media** Cold and hot water, water with glycol up to max. 50% vol.
- Medium temperatures** The permissible medium temperatures can be found in the corresponding valve and actuator data sheets.

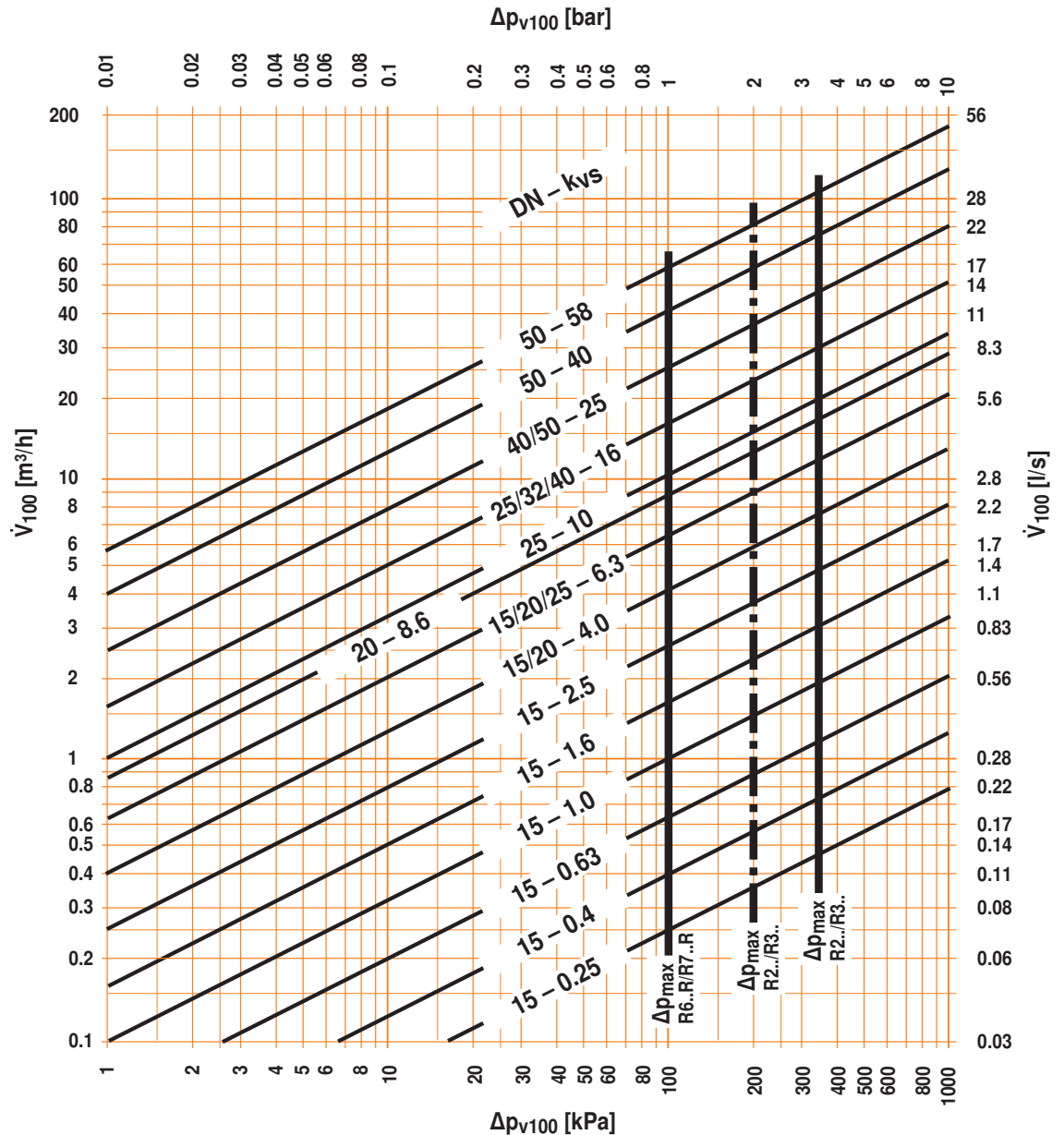

— Δp_{max}
 Maximum permitted differential pressure for long service life across control path A – AB, with reference to the whole opening range.

----- Δp_{max}
 For low-noise operation (R2../R3..)

Δp_{v100}
 Differential pressure with ball valve full open.

\dot{V}_{100}
 Nominal flow rate with Δp_{v100}

Formula k_{vs}

$$k_{vs} = \sqrt{\frac{\dot{V}_{100}}{\frac{\Delta p_{v100}}{100}}}$$

k_{vs} [m³/h]
 \dot{V}_{100} [m³/h]
 Δp_{v100} [kPa]

Calculation diagram for 2-way and 3-way characterised control valves R4..(K) / R5..(K)

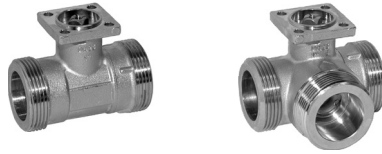

Application These characterised control valves are used in open and closed cold and hot water systems for modulating water-side control of air treatment and heating plants.

Media Cold and hot water, water with glycol up to max. 50% vol.

Medium temperatures The permissible medium temperatures can be found in the corresponding valve and actuator data sheets.

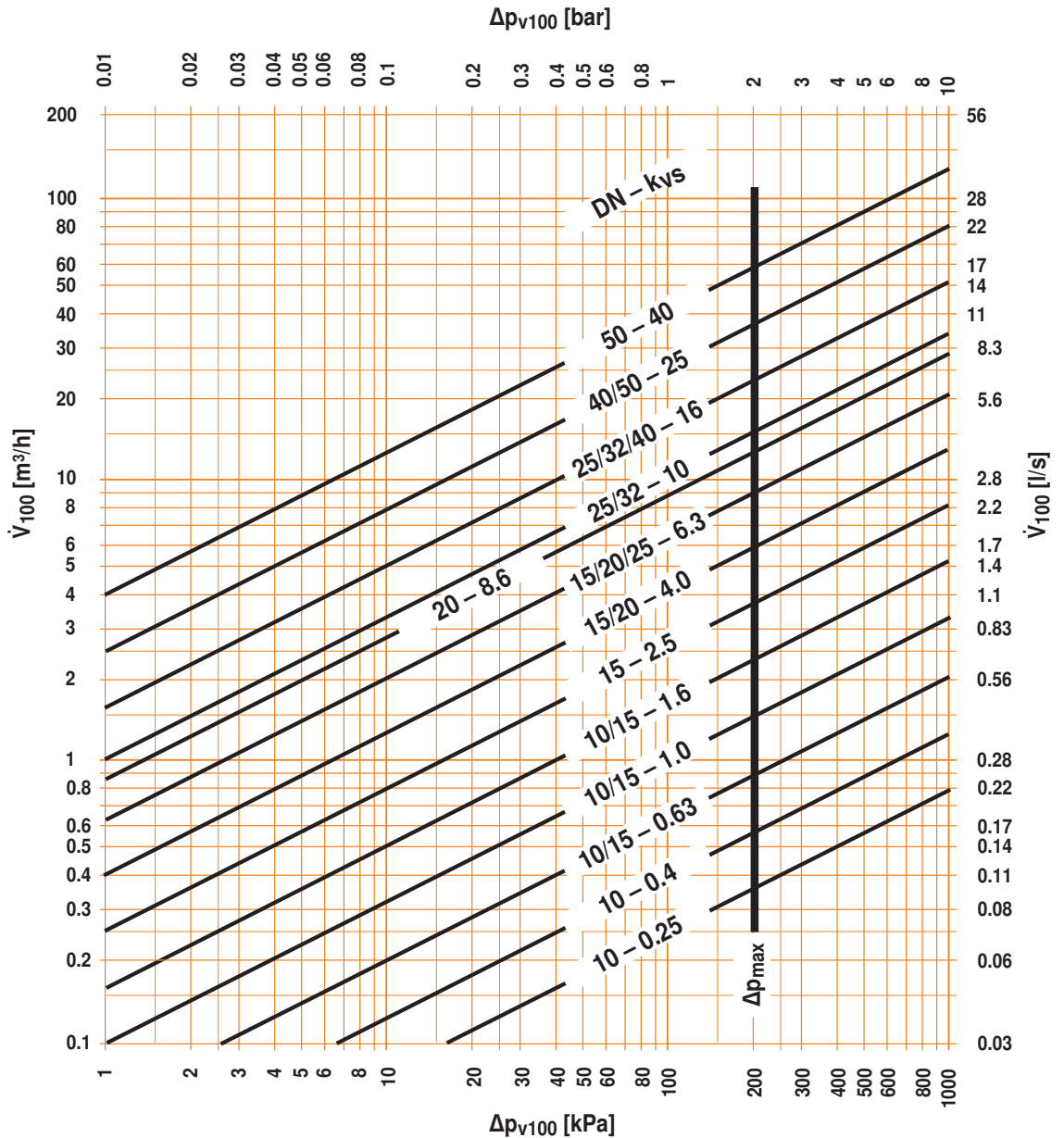

Δp_{max}
Maximum permitted differential pressure for long service life across control path A – AB, with reference to the whole opening range.

Δp_{v100}
Differential pressure with ball valve full open.
 \dot{V}_{100}
Nominal flow rate with Δp_{v100}

Formula k_{vs}

$$k_{vs} = \frac{\dot{V}_{100}}{\sqrt{\frac{\Delta p_{v100}}{100}}}$$

k_{vs} [m³/h]
 \dot{V}_{100} [m³/h]
 Δp_{v100} [kPa]

Calculation diagram for 2-way characterised control valves R6..W..-S8



Application These characterised control valves are used in closed cold and hot water systems for modulating water-side control of air treatment and heating plants.

Media Cold and hot water, water with glycol up to max. 50% vol.

Medium temperatures -10 ... 120°C

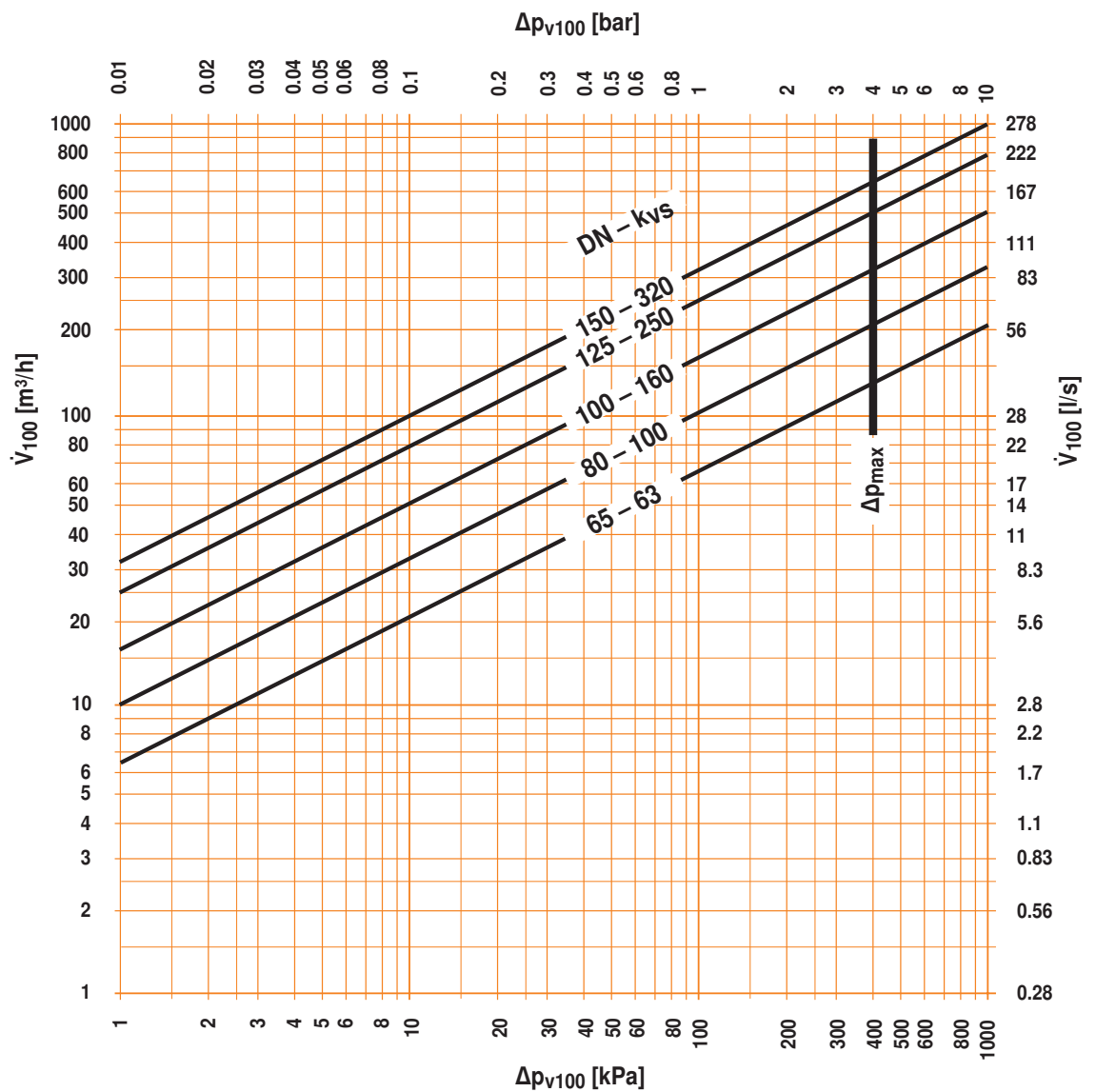

Δp_{max}
Maximum permitted differential pressure for long service life across control path A – AB, with reference to the whole opening range.

Δp_{v100}
Differential pressure with ball valve full open.

V₁₀₀
Nominal flow rate with Δp_{v100}

Formula k_{vs}

$$k_{vs} = \frac{\dot{V}_{100}}{\sqrt{\frac{\Delta p_{v100}}{100}}}$$

k_{vs} [m³/h]
 \dot{V}_{100} [m³/h]
 Δp_{v100} [kPa]

Calculation diagram for 2-way characterised control valves R4..D(K)



Application These characterised control valves are used in open and closed cold and hot water systems for modulating water-side control of water in district heating applications.

Media Cold and hot water, water with glycol up to max. 50% vol.

Medium temperatures 2...130°C

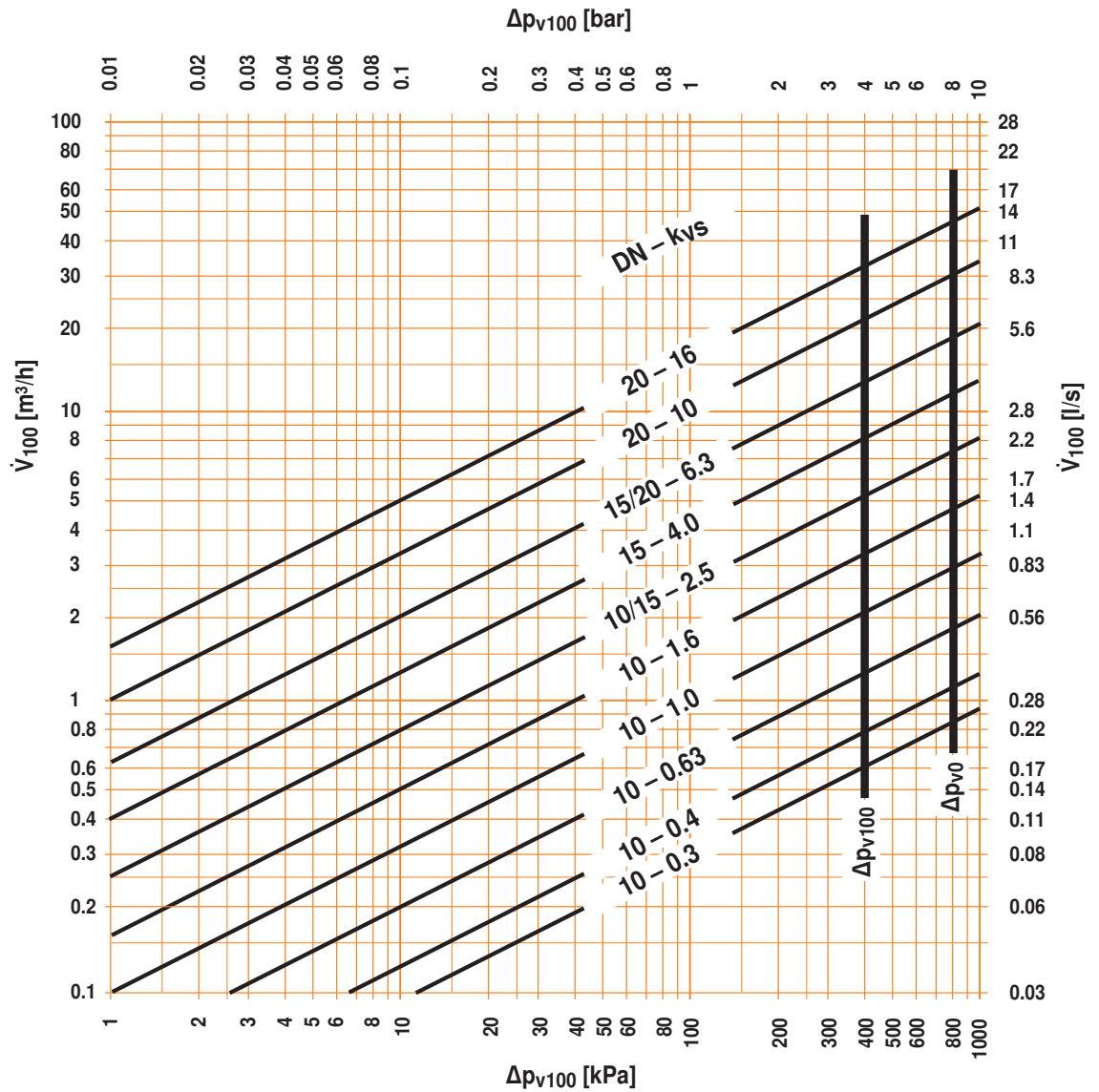

— Δp_{v0}
maximum permissible differential pressure for long service life with closed ball valve

— Δp_{v100}
maximum permissible differential pressure for long service life with ball valve full open

\dot{V}_{100}
Nominal flow rate with Δp_{v100}

Formula k_{vs}

$$k_v = \frac{\dot{V}_{100}}{\sqrt{\frac{\Delta p_{v100}}{100}}}$$

k_{vs} [m³/h]
 \dot{V}_{100} [m³/h]
 Δp_{v100} [kPa]

Calculation diagram for 2-way characterised control valves R4..D(K)

Differential pressure

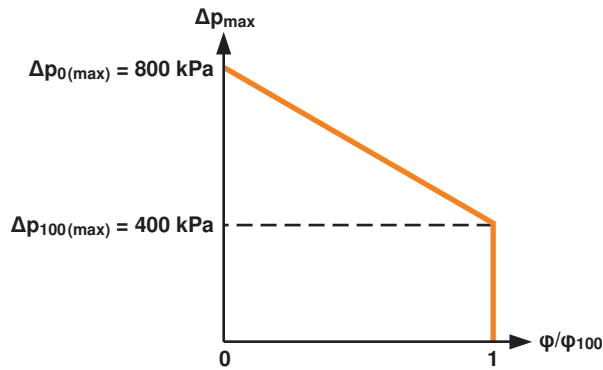

Δp_{max} = maximum permissible differential pressure
 p_{v0} = maximum permissible differential pressure with valve closed
 p_{v100} = maximum permissible differential pressure with valve completely open
 ϕ = actuating angle
 ϕ_{100} = actuating angle with valve completely open

Operating pressure ratio X_F

Formula

$$X_F = \frac{\Delta p}{p_1 - p_v} < X_{FZ}$$

$$\Delta p < X_{FZ} (p_1 - p_v)$$

$$X_F \leq Z = X_{FZ}$$

Δp = $p_1 - p_2$ = Differential pressure over the valve [bar]
 p_v = steam-pressure water [bar abs.]
 X_F = operating pressure ratio
 X_{FZ} = start of cavitation of the valve
 Z = cavitation factor of the valve

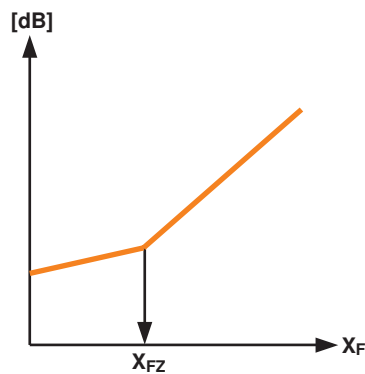



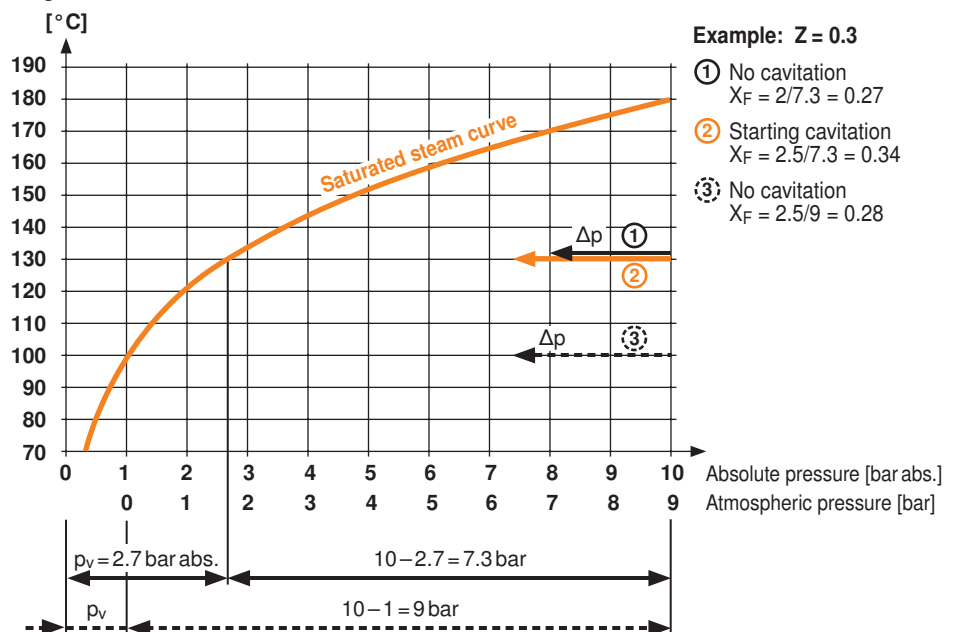













Cavitation factor Z Diagram



Example: $Z = 0.3$

- ① No cavitation
 $X_F = 2/7.3 = 0.27$
- ② Starting cavitation
 $X_F = 2.5/7.3 = 0.34$
- ③ No cavitation
 $X_F = 2.5/9 = 0.28$

Characterised control valve selection table

Rated pressure p_s [kPa] pressure class	1600 PN 16				600 PN 6		1600 PN 16	2700 PN 16
Max. differential pressure Δp_{max} [kpa]	350 (200 for low-noise operation)		200		100		400	400
Valve design (2-way / 3-way)								
Internal thread (ISO 7-1)								
External thread (ISO 228-1)								
Flange (ISO 7005-1/2)								
Valve characteristic curve — Control path A–AB - - - - - Bypass B–AB								
Characterised control valves	R2..	R3..	R4..	R5..	R6..R	R7..R	R6..W..	R4..D(K)
k_{vs}	DN							
0.25	10			R405K	R505K			
	15	R2015-P25-S1	R3015-P25-S1					
0.3	10							R404DK
0.4	10			R406K	R506K			R405DK
	15	R2015-P4-S1	R3015-P4-S1					
0.63	10			R407K	R507K			R406DK
	15	R2015-P63-S1	R3015-P63-S1	R409	R509	R6015RP63-B1	R7015RP63-B1	
1	10			R408K	R508K			R407DK
	15	R2015-1-S1	R3015-1-S1	R410	R510	R6015R1-B1		
1.6	10			R409K				R408DK
	15	R2015-1P6-S1	R3015-1P6-S1	R411	R511	R6015R1P6-B1	R7015R1P6-B1	
2.5	10							R409DK
	15	R2015-2P5-S1	R3015-2P5-S1	R412	R512	R6015R2P5-B1		R412D
4	15	R2015-4-S1	R3015-4-S1	R413	R513	R6015R4-B1	R7015R4-B1	R413D
	20	R2020-4-S2	R3020-4-S2	R417	R517			
6.3	15	R2015-6P3-S1		R414				R414D
	20	R2020-6P3-S2	R3020-6P3-S2	R418	R518	R6020R6P3-B1	R7020R6P3-B1	R417D
	25	R2025-6P3-S2	R3025-6P3-S2	R422	R522			
8.6	20	R2020-8P6-S2		R419				
10	20							R418D
	25	R2025-10-S2	R3025-10-S2	R423	R523	R6025R10-B2	R7025R10-B2	
16	20							R419D
	25	R2025-16-S2		R424				
	32	R2032-16-S3	R3032-16-S3	R431	R531	R6032R16-B3	R7032R16-B3	
	40	R2040-16-S3	R3040-16-S3	R438	R538		R7040R16-B3	
25	40	R2040-25-S3	R3040-25-S4	R439		R6040R25-B3		
	50	R2050-25-S4	R3050-25-S4	R448	R548		R7050R25-B3	
40	50	R2050-40-S4	R3050-40-S4	R449		R6050R40-B3		
58	50		R3050-58-S4					
63	65							R6065W63-S8
100	80							R6080W100-S8
160	100							R6100W160-S8
250	125							R6125W250-S8
320	150							R6150W320-S8

Medium temperature

The permissible medium temperatures can be found in the corresponding valve and actuator data sheets.

Leakage rate



2-way: Leakage rate A, air bubble tight (EN 12266-1)

3-way: Control path A – AB leakage rate A, tight (EN 12266-1)

Bypass B – AB leakage rate class I (EN 1349 and EN 60534-4), max. 1% of k_{vs} value

- For all possible combinations with rotary actuators and their closing pressures and maximum permissible differential pressures, see the document "Overview Valve-actuator combinations"
- For detailed information concerning rotary actuators, see the data sheets for the rotary actuators

Dimensioning and selection table for 2-way and 3-way open-close ball valves

Differential pressure Δp_{\max} [kPa]	0.1	1.0	3.0	10.0	k_{vs} [m ³ /h]	DN [mm]			
Flow rate \dot{V}_{100} [m ³ /h]	0.13	0.4	0.69	1.3	4	10	R410DK		
	0.17	0.55	1.0	1.7	5.5	15			R3015-BL1
	0.27	0.86	1.5	2.7	8.6	15	R415	R515	
	0.28	0.9	1.6	2.8	9	32			R3032-BL2
	0.32	1.0	1.7	3.2	10	25			R3025-BL2
	0.35	1.1	1.9	3.5	11	20			R3020-BL2
	0.38	1.2	2.1	3.8	12	15	R415D		
	0.44	1.4	2.4	4.4	14	40			R3040-BL3
	0.47	1.5	2.6	4.7	15	15	R2015-S1 R6015R-B1	R3015-S1 R7015R-B1	
						32			R3032-BL3
	0.51	1.6	2.8	5.1	16	32	R430	R530	
	0.66	2.1	3.6	6.6	21	20	R420	R520	
	0.76	2.4	4.2	7.6	24	50			R3050-BL3
	0.79	2.5	4.3	7.9	25	20	R420D		
	0.82	2.6	4.5	8.2	26	25	R2025-S2 R425 R6025R-B2	R3025-S2 R525 R7025R-B2	
						40	R2040-S3 R6040R-B3	R3040-S3 R7040R-B3	
	1.0	3.1	5.4	9.8	31	20	R2020-S2 R6020R-B1	R3020-S2 R7020R-B1	
						32	R2032-S3 R432 R6032R-B3	R3032-S3 R532 R7032R-B3	
						40	R440	R540	
	1.5	4.7	8.1	14.9	47	40			R3040-BL4
1.6	4.9	8.5	15.5	49	50	R2050-S4 R450 R6050R-B3	R3050-S4 R550 R7050R-B3		
					50			R3050-BL4	
2.4	7.5	13.0	23.7	75	50			R3050-BL4	

$$\text{Formula } \dot{V}_{100} \dot{V}_{100} = k_{vs} \sqrt{\frac{\Delta p_{v100}}{100}}$$

k_{vs} [m³/h]
 \dot{V}_{100} [m³/h]
 Δp_{v100} [kPa]

Connections: R2.. / R3.. Internal thread
 R4.. / R5.. External thread
 R6.. / R7.. Flange

All-inclusive



Belimo Europe

BELIMO Automation AG
Brunnenbachstrasse 1
CH-8340 Hinwil, Switzerland

Tel. +41 43 843 61 11
Fax. +41 43 843 62 68
info@belimo.ch
www.belimo.ch

Belimo worldwide: www.belimo.com

BELIMO[®]